



FULL NDI® PTZ CAMERA. LEVELLED UP.



# USER GUIDE

October 2023



## Table of Contents

Welcome to BirdDog! .....	3
Using This Manual .....	3
First Step .....	3
BirdDog P120 Overview .....	4
Welcome to the Future .....	5
What's in the Box? .....	6
Optional Accessories .....	6
Quick Start Guide .....	7
Basic Connections.....	7
Power Up.....	7
Computer, say hello to the P120 .....	7
Basic Configuration.....	8
Camera Connections .....	11
Remote Controller .....	13
Powering the P120 .....	14
Video Output .....	15
Audio Input / Output.....	15
Using the Camera Menus.....	16
Camera Menus .....	17
White Balance Menu .....	17
Picture 1 Menu .....	18
Picture 2 Menu .....	18
Pan Tilt Zoom Menu.....	18
System Menu.....	19

<b>Controlling the Camera with the Remote Controller .....</b>	<b>20</b>
Panning and Tilting .....	20
Zooming .....	21
Focusing .....	21
Shooting with Back Lighting .....	21
Changing Resolution .....	22
Storing the Camera Settings in Memory Using Presets .....	22
Operating Multiple Cameras with the Infrared Remote Controller .....	23
<b>Web Configuration Panel .....</b>	<b>24</b>
Password Management .....	24
<b>BirdUI Layout.....</b>	<b>25</b>
<b>Dashboard .....</b>	<b>26</b>
<b>Network .....</b>	<b>27</b>
NDI Network Settings .....	27
<b>System.....</b>	<b>29</b>
System Update .....	29
Access Manager Configuration .....	30
System Reboot.....	30
<b>AV Setup .....</b>	<b>31</b>
NDI Encode Settings.....	31
<b>CamControl.....</b>	<b>33</b>
FreeD Tab .....	33
Preset Tab.....	33
Exposure Tab.....	34
White Balance Tab .....	34
Picture Tab .....	35
Colour Matrix Tab .....	36
<b>Scopes .....</b>	<b>37</b>
<b>Receiving NDI® Video .....</b>	<b>38</b>
<b>NDI® Camera Control .....</b>	<b>39</b>
IP Connection.....	39

Remote Controller.....	39
Controlling Your Camera Via Other Protocols .....	40
Camera Initial Setting Status Information.....	40
VISCA over IP Control.....	41
Setting the DIP Switch.....	42
Using RS-232 (VISCA).....	44
Using RS422(VISCA) / RS485 (PELCO P/D) .....	46
PELCO P/D Keyboard RS485 Connection .....	48
Camera Dimensions .....	50
Glossary.....	51



## Copyright

Copyright 2023 BirdDog Australia all rights reserved. No part of this manual may be copied, reproduced, translated, or distributed in any form or by any means without prior consent in writing from our company.

## Trademark Acknowledgement

 BirdDog and other BirdDog trademarks and logos are the property of BirdDog Australia. Other trademarks, company names and product names contained in this manual are the property of their respective owners.

- Microsoft, Windows, ActiveX, and Internet Explorer are registered trademarks of Microsoft Corporation in the U.S. and/or other countries.
- HDMI, the HDMI logo and High-Definition Multimedia Interface are the trademarks or registered trademarks of HDMI Licensing, LLC in the United States and other countries.
- Other trademarks, company names and product names contained in this manual are the property of their respective owners.
- NDI® is a registered trademark of NewTek, Inc.

## Important Information

### Legal Notice

To ensure account security, please change the password after your first login. You are recommended to set a strong password (no less than eight characters).

The contents of this document are subject to change without prior notice. Updates will be added to the new version of this manual. We will readily improve or update the products or procedures described in the manual.

Best effort has been made to verify the integrity and correctness of the contents in this document, but no statement, information, or recommendation in this manual shall constitute formal guarantee of any kind, expressed or implied. We shall not be held responsible for any technical or typographical errors in this manual.

The product appearance shown in this manual is for reference only and may be different from the actual appearance of your device. Due to uncertainties such as physical environment, discrepancy may exist between the actual values and reference values provided in this manual.

Use of this document and the subsequent results shall be entirely on the user's own responsibility.

### Warnings

- If the product does not work properly, please contact your dealer. Never attempt to disassemble the camera yourself. (We will not assume any responsibility for problems caused by unauthorized repair or maintenance.)
- This installation should be made by a qualified service person and should conform to all the local codes.
- When shipping, the camera should be packed in its original packaging.
- Ensure the power supply voltage is correct before using the camera.
- Do not drop the camera or subject it to physical shock.
- If the camera will not be used for an extended period of time, attach the lens cap to protect the lens.
- Do not aim the camera lens directly at the sun. This may cause irreversible damage to the camera.



### Maintenance Precautions

- If there is dust on the front glass surface, remove the dust gently using an oil-free brush or a rubber dust blowing ball.
- If there is grease or a dust stain on the front glass surface, clean the glass surface gently from the center outward using anti-static gloves or an oil-free cloth. If the grease or the stain still cannot be removed, use anti-static gloves or an oil-free cloth dipped with detergent and clean the glass surface gently until it is removed.
- Do not use organic solvents, such as benzene or ethanol when cleaning the front glass surface.

## Regulatory Compliance

### FCC Part 15

This equipment has been tested and found to comply with the limits for digital device, pursuant to part 15 of the FCC Rules. These limits are designed to provide reasonable protection against harmful interference when the equipment is operated in a commercial environment.

This equipment generates, uses, and can radiate radio frequency energy and, if not installed and used in accordance with the instruction manual, may cause harmful interference to radio communications. Operation of this equipment in a residential area is likely to cause harmful interference in which case the user will be required to correct the interference at his own expense.

This product complies with Part 15 of the FCC Rules. Operation is subject to the following two conditions:

- This device may not cause harmful interference.
- This device must accept any interference received, including interference that may cause undesired operation.

### LVD/EMC Directive

This product complies with the European Low Voltage Directive 2006/95/EC and EMC Directive 2004/108/EC.



## Welcome to BirdDog!

Thank you for purchasing your P120 camera. If you have any questions regarding the camera, please contact your authorized dealer.

Our website also has a [User Stories](#) page to help inspire you to get the most out of your camera.

## Using This Manual

Your P120 is a powerful and sophisticated device, so please read this manual before use and retain for future reference.

If you are new to the world of NDI® or BirdDog cameras, begin with the [Quick Start Guide](#). This will give you a good introduction to the setup of your new camera.

### Tip

When viewing the diagrams in this manual, use the zoom controls in your browser or PDF reader to reveal more detail.

## First Step

### Firmware Upgrade

Before you use your new P120, it's a good idea to upgrade to the latest firmware. We are always adding new features and improving the performance of our products, so installing the latest firmware will provide you with the best user experience.

To upgrade the firmware, please follow the **Firmware Upgrade Instructions** located in your firmware download folder and perform upgrade process.

The latest firmware files are available for download here: [Firmware Updates](#)

## We're Invested In Your Success

We pride ourselves on being approachable and easily contactable. We'd love to hear from you.

Dan Miall

Co-Founder and CEO  
[dan@bird-dog.tv](mailto:dan@bird-dog.tv)



# BirdDog P120 Overview

## Camera Features

- Resolution: Up to 1080P60, 1080i60
- Lens: 5.2-104mm
- Zoom: Optical 20X Digital: 16X
- Shutter Speed: 1/1 – 1/10,000 sec
- Video Output: HDMI, 3G-SDI, NDI® and USB video.
- Onboard OLED display: 5-line, RGB color
- Tally display: Bi-colour full 360 degree viewable Mohawk Tally, and rear camera numbering system
- ±350-degree continuous pan, ±120-degree continuous tilt
- 128 presets, Speed up to 150 degrees/sec
- Standard mounting and ceiling mounting with E-Flip function
- Control supports RS-232 control, RS-422/485 control, VISCA-over-IP, NDI® Control, IR Remote Controller
- Network Protocol Support: NDI® Discovery, configuration and control, NDI® |HX2, SRT, Cloud Connect, RTSP, RTMP
- Presets store camera directions and image parameters. (Up to 6 presets on remote controller or 128 presets via protocol programming)
- Image parameter setting restore with presets and quick access operation
- Supports audio input and audio output with NDI® streaming
- Power: DC 12V, PoE+(IEEE802.3at)





# Welcome to the Future

## What is NDI®?

Your new P120 camera has been designed to support the cutting edge NDI® video transmission standard.

NDI® (Network Device Interface) is a high-quality, low-latency, frame-accurate standard that enables compatible devices to communicate, deliver, and receive high definition video over your existing Gigabit Ethernet network.

Operating bi-directionally, NDI® devices can be auto-detected, powered and controlled over the same Ethernet cable used to send the video and audio. If you have a Gigabit network, you have the potential for a streamlined, interconnected, video production environment.

With the introduction of NDI® 5, you can now securely share network sources between remote sites anywhere in the world – on a single network port. Even a smartphone can be a NDI® source.

Transitioning to NDI® can also occur gradually. Existing SDI or HDMI signals can easily be converted to an NDI® stream and piped where required on your network and converted back only at the necessary endpoints.

BirdDog has been on the NDI® journey since the very beginning, and your P120 is just one of our products designed to take advantage of the features and potential of NDI®.

For more information on NDI®, please refer to this [page](#) on our website.

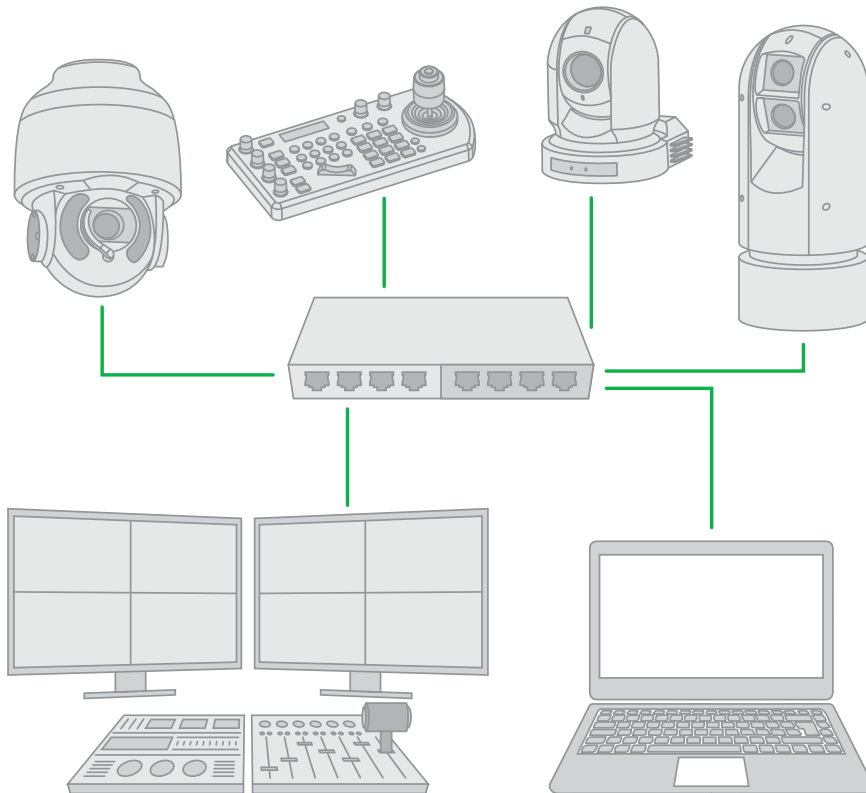



## What's in the Box?

**NOTE:** The camera color may be white or black in colour depending on the item purchased. Optional



1x BirdDog P120



1x IR Remote Controller  
(3V CR2032 Coin Lithium Battery Required)



1x camera Power Adaptor



1x bag of Camera Mounting Screws and Tally  
Light Number Inserts

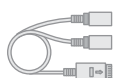

1x USB to 3.5mm Audio Cable

## Optional Accessories

Depending on your requirements, you may need to purchase these optional accessories. Please browse to this [page](#) on our website for all your accessory needs.

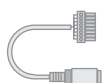

RS232 8 pin mini DIN to Phoenix terminal block



Wall Mount



Ceiling Mount

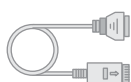

RJ45 to RS422 adaptor cable



## Quick Start Guide

If you are new to the world of NDI® or BirdDog cameras, please follow this quick start guide to become familiar with the basic setup of your new camera. You can also view a similar online [video](#).

Be sure to check the many helpful product videos on our YouTube [page](#).

## Basic Connections

### Power

To start using your new camera, you'll have to decide how you are going to power the device. You have two choices. You can use PoE+ (Power over Ethernet) or, if your network doesn't support PoE+, you can use the included 12VDC power adaptor. If available, PoE is the easier choice, since you can use the same Ethernet cable to power and control the camera, as well as send the video. For the purposes of this quick start guide, we'll use the power adaptor, so plug the jack into the 12VDC power port on the back of the camera.

### Network

Since we're supplying power via the adaptor, the NDI®/PoE Ethernet connection will be used purely for NDI® video. Let's keep things simple and plug an Ethernet cable directly from your computer into the camera NDI®/PoE Ethernet port.

## Power Up

Once you've made the power and Ethernet connections, turn on the adapter power. When first powered up, the camera will perform its initialization routine by rotating to the left and then centering again. When this is finished, the indicator light on the front of the camera will display green (and occasionally amber) and the camera is ready to be accessed.

## Computer, say hello to the P120

Since we're connecting your camera directly to your computer, we need to configure the network settings of your computer to allow communication with the camera.

Navigate to the Network Properties in your computer preferences and make the following settings.

The screenshot shows a network configuration window with a green border. It contains two radio buttons at the top: 'Obtain an IP address automatically' (unselected) and 'Use the following IP address:' (selected). Below the radio buttons are three input fields:

IP address:	192 . 168 . 100 . 123
Subnet mask:	255 . 255 . 255 . 0
Default gateway:	192 . 168 . 100 . 1

Select **Use the following IP address:** and enter an IP address. The default IP address of the camera is 192.168.100.100, so we need to enter an address where the first three numbers are the same as the camera IP address, i.e., 192.168.100 but the last number is a different number, in the range of 0 – 255, that is not currently assigned. Usually numbers less than 200 are more likely to be available. The subnet mask can be set as shown.

The P120 and the computer are now configured on the same subnet and should be able to communicate with each other.



## Basic Configuration

### NDI® Tools

NDI® Tools is a free suite of applications designed to introduce you to the world of IP video and is available [here](#).

Once installed, launch the Studio Monitor (Video Monitor, if using a Mac) application. This simple application allows you to view all NDI® sources on your network. Right click on the Studio Monitor window to view your camera as an NDI® source. In the example to the right, three cameras and a desktop computer are shown as NDI® sources.

### Tip

By default, the displayed sources have names that include the last five digits of your camera MAC address which is displayed on the bottom of the camera.

Clicking on your camera in the source list will display the image from your camera with the default automatic settings.

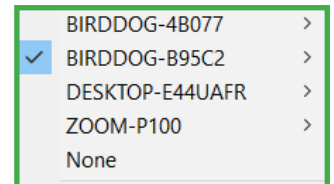

## The BirdUI

The screenshot displays the BirdUI dashboard with the following sections:

- System Info:** A circular progress indicator shows 35% completion. Below the indicator is the text "System Info" and "extra text".
- Device Mode:** Encode
- Source Status:** Streaming NDI To 5
- Network Bandwidth:** A circular progress indicator shows 27% usage. Below the indicator is the text "Network Bandwidth" and "extra text".
- Status:** A section containing three items: "NDI Video Stream Name: CAM", "Video Format: 1080p59.94", and "Audio Status: Mute".
- Stream Info:** A section containing six items: "Video Resolution: 1920x1080", "Video Frame Rate: 59.94", "Video Sample Rate: 422", "Audio Channels: 2", "Audio Sample Rate: 48000", and "Average Bitrate: 87Mbps".
- System Details:** A section containing six items: "System Name: birddog-p200a4 (CAM 1)", "IP Address: 192.168.2.107", "Firmware Version: BirdDog P200A4\_A5 5.0.020", "MCU Version: 18", "MAC Address: 80:1f:12:fa:41:ee", and "Network Config Method: dhcp".
- Status:** inactive

BirdDog cameras have a web interface (BirdUI) that is displayed by your computer browser and can be used to configure your camera remotely.

1. Click on the gear icon on the bottom right of the Studio Monitor window.
2. In the displayed window, type the default password 'birddog' (all lower case) and click the OK button. The Dashboard window is displayed.

The Dashboard shows important basic camera settings. For now, check that the displayed Status is Active and take note of the frame rate that is currently output from the camera (displayed under NDI® connection info). This frame rate should be set identically for all cameras according to the requirements of your production. Let's see how to change this and other important camera settings.



## NDI Encode Settings

### Bitrate Management

Because you're sending NDI® video over your computer network, you may need to be mindful of the amount of bandwidth your video will consume. By setting Bitrate Management to NDI MANAGED, the target bitrate will be set in accordance with the NDI® standard. This will achieve an optimum balance between bandwidth consumption and video quality. In this mode, the video bitrate will be around 120–140 Mbps. If you do opt for Manual management, you may select a target bitrate within a range of 60–360 Mbps. Do this with care, as the actual bitrate may be greater, straining the capacity of the network and the receiving device, and lower settings may result in reduced image quality.

### NDI Video Format

Here you can set the frame rate of the camera to match that of your production. All cameras should be set to the same frame rate.

### NDI Group

NDI® supports **Grouping** which allows you to hide the visibility of video sources to viewers that are not part of the group. If disabled, the video source is public and viewable by any receiver on your network.

### Stream Name

Give the output video stream of the camera a memorable name to make identification easier on NDI® receiving devices.

### NDI Audio

You can choose to embed audio from the audio input connector into the NDI® stream or mute it.

### NDI Failover Source

If the selected HDMI source is interrupted for any reason, the P120 can automatically switch to a pre-determined alternative NDI® source. Select an available NDI® source for the failover function from the *Available NDI® sources* dropdown list. Pressing the Refresh button will add new sources to the list, whereas pressing Reset will populate the list with only active NDI® sources. Click the Apply button to apply your failover source change.



## Network Configuration

Network Details			
Configuration Method	<input type="radio"/> STATIC <input checked="" type="radio"/> DHCP	DHCP Timeout	20
IP Address	192.168.2.132	DHCP Fallback IP Address	192.168.100.100
Subnet Mask	255.255.255.0	DHCP Fallback Subnet Mask	255.255.255.0
Gateway Address	192.168.2.1	BirdDog Name	zoom-p120 <small>Local</small>
<input type="button" value="APPLY"/>			

For the final part of this quick start guide, let's set up the network configuration of your camera so it can work with your wider network.

Most computer networks provide for both automatic and manual configuration of network devices and the P120 can accommodate both.

### Static or DHCP

Here you can set the network configuration to either DHCP (default) or Static. DHCP simplifies the management of IP addresses on networks. No two hosts can have the same IP address, so assigning them manually can potentially lead to errors. If your network is set up for DHCP, this is generally the best configuration to choose.

If you do choose to go with a Static IP address, you'll need to add the IP Address, Subnet Mask and Gateway Address information according to the requirements of your network.

### DHCP Timeout, Fallback IP address, Fallback Subnet Mask

You can set the timeout period during which the P120 will look for a DHCP IP address. After this period, the camera will default to the designated fallback IP address.

This can be useful if you use your camera in other network environments. For example, if a DHCP server is available in your normal office or studio application, the camera will use the DHCP supplied IP address. If you then use the camera in another application without a DHCP server, your camera will always default to the known fallback IP address.

### BirdDog Name

You can give your camera a meaningful name to make identification easier when viewing NDI® sources on a receiver such as a TriCaster, vMix or Studio Monitor. Be sure to make the name unique, as no two devices on the network should have the same name. The name can be any combination of 'a-z, 0-9, and -'.

After renaming your camera, navigate back to the Dashboard and click REBOOT DEVICE. The camera will re-initialize and you'll be good to go.

**NOTE:** Your computer will need to have 'Bonjour' services loaded in order to access the unit via its user defined name. Apple devices come pre-installed with Bonjour, while Windows devices need a plugin available from [here](#).

## You're Done!

That concludes our quick start guide for the P120. Your camera has many other features, so to get the most out of your camera, please review the rest of this manual.

To learn about more advanced camera options, such as exposure, white balance and colour management, please refer to [here](#) in this manual.



## Camera Connections

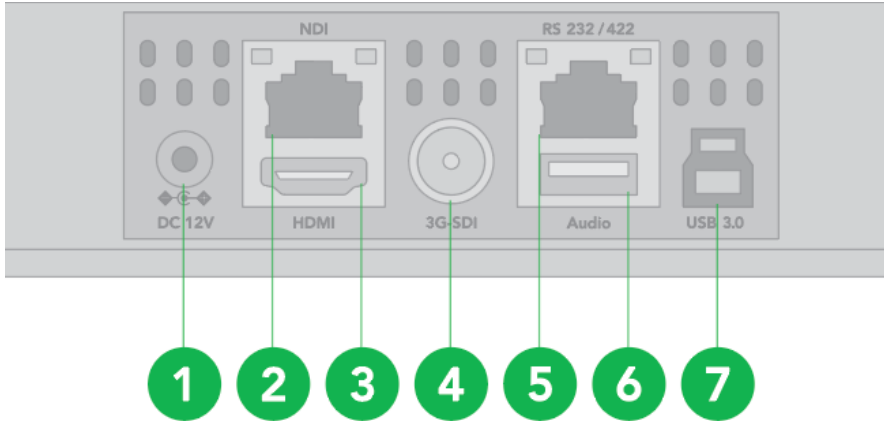

### 1. 12V DC Power Port

Connect the supplied DC power adaptor.

### 2. NDI Ethernet Port

For VISCA over IP control and NDI® output. Supports PoE+(IEEE802.3at).

### 3. HDMI Port (HDMI 1.4)

### 4. 3G-SDI Video Output

### 5. RS-232/422 Control Port (RJ45)

RJ45 to RS-232/422 convertor cable is provided.

### 6. USB Port

Used for audio in/out, USB port to 3.5mm audio jack adaptor included. Audio format is stereo, unbalanced line level.

### 7. USB 3.0 Port (TYPE B)

Used for USB video and baseboard update.

### 8. Tally Light

### 9. Lens

20x zoom lens.

### 10. Power LED Indicator

Turns green when the camera is connected to power outlet. When the power is turned on, it takes about 15 to 30 seconds to display the image after LED turns on. Flashes orange when the camera receives commands from the infrared remote controller.

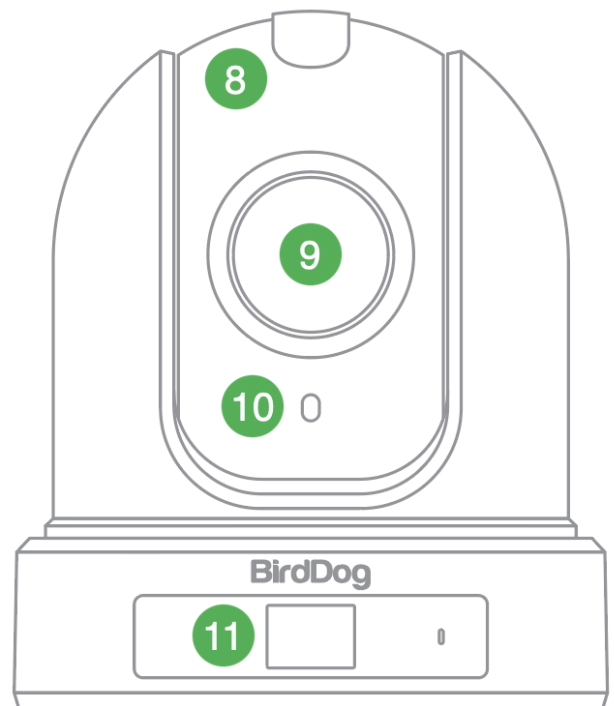



### 11. OLED Display

Displays camera model, IP address, camera name and resolution.

```
BirdDog P120  
192.168.1.120  
birddog-m4r74  
CAM  
1080p59.94
```

### 12. Tally light number

### 13. Fixed Mounting Holes

For original wall/ceiling mount bracket

### 14. Tripod mounting holes

### 15. Base DIP Switch

Used for setting the camera configuration. For details, refer to [Setting the DIP Switch](#).

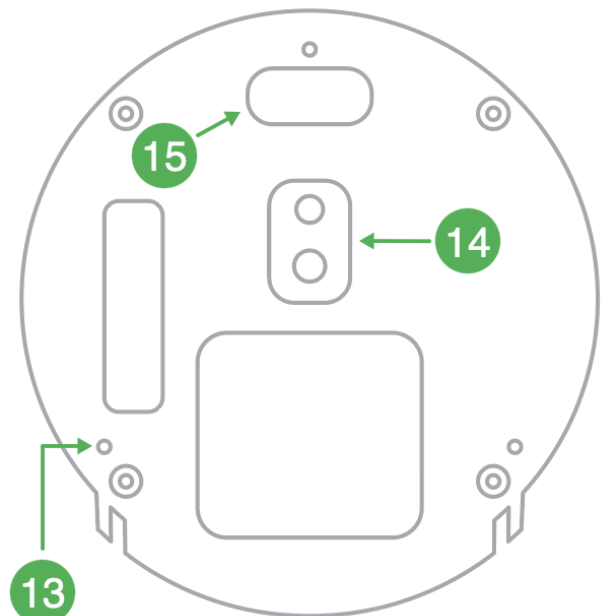





# Remote Controller

## 1. Power

- Power ON the camera to set the camera to operational status.
- Power OFF the camera to set the camera to standby status.
- When the camera is powered OFF, the camera turns to the rear.
- When the camera is powered ON, the camera turns to the front.
- Powering the camera ON/OFF would not restart the camera.

## 2. Camera ID (Total 3) Selector

## 3. Preset Position (Total 6) Calling and Setting

## 4. PAN-TILT

- Pan and Tilt direction control.
- HOME: Home position, Resolution reset.

## 5. L/R Direction Set

- Left and right orientation setting.

## 6. ZOOM/FOCUS

- Far: for objects further from the camera.
- Near: for objects closer to the camera.

## 7. Auto/Manual Focus

## 8. Back Light

## 9. Video Format Switching

- You can change the video format by keep pressing the button. (When video format is changed, the camera would restart and the screen turns black for few seconds.)

## 10. MENU

- On screen menu display ON/OFF.

## 11. Fast/Slow Zooming Speed Switching

## 12. White Balance

- Change the White Balance setting by pressing the button.

## 13. De-Flicker

- When you find the video flicking, press the button once to eliminate flickering.

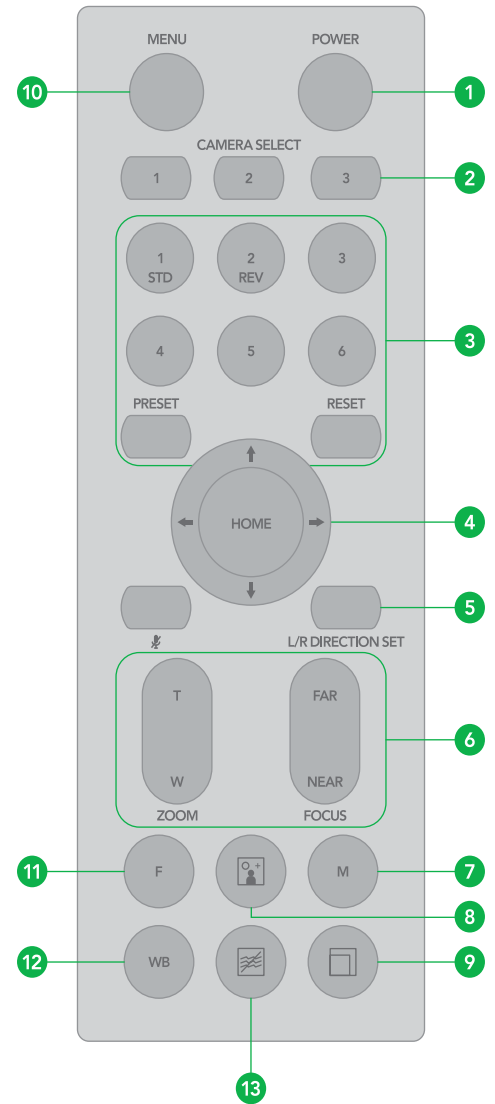



## Powering the P120

The P120 can be powered in two ways.

- **PoE+ (Power over Ethernet)**

PoE+ is a convenient way to power the P120 as it allows both data and power to be sent through the same standard Ethernet cable. The network switch must support PoE+ (802.3at).

- **DC Connection**

Located at the rear of the P120 is a 12VDC connection port. Use only the DC power adaptor (JEITA type4) supplied with the unit.

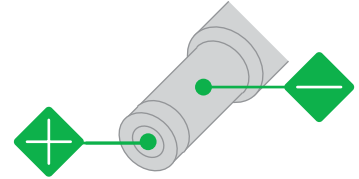

### **WARNING**

Do not attempt to manually move the camera head when the device is powered up. Doing so may damage the camera.



## Video Output

The camera can simultaneously output SDI, HDMI, NDI® and USB (UVC) video.

### HDMI Signal

1. Connect the camera to a HD monitor/TV using HDMI cable.
2. Turn on the camera. After initialization, video will display on the monitor.
3. Information of the camera initial setting status will display on the monitor for 5 seconds.
4. You can set the displayed video format in the camera System menu.

### SDI Signal

1. Connect your camera to the SDI Device/display with an SDI cable.

### NDI Signal

1. Connect the camera to the network using a CAT5/CAT6 network cable.
2. You'll need to use web browser on a connected computer for camera configuration.
3. To obtain NDI® video and configure NDI® video, please refer to [NDI Network Settings](#).

### USB Video Signal

1. Connect the camera to your USB device/display with a type B cable.

## Audio Input / Output

Analog 3.5mm audio In\Out ports. The Audio Out will output any audio that is captured on the Audio In port. Audio format is stereo, unbalanced line level.

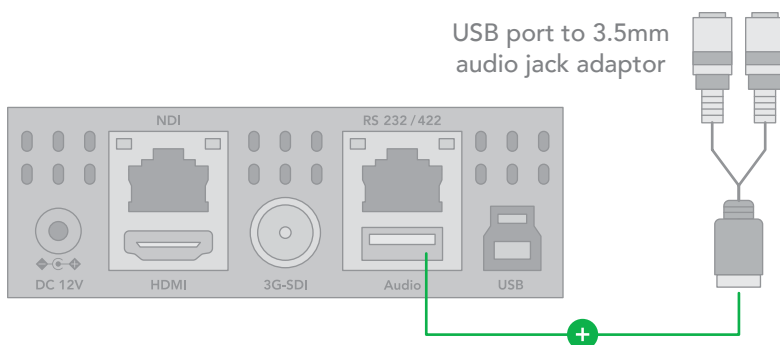



## Using the Camera Menus

You can use the infrared remote controller to change camera settings while viewing the On Screen Display (OSD) menus on a connected monitor. The OSD is viewable over NDI®, SDI or HDMI.

However, the [Web Configuration Panel](#) (BirdUI) affords greater control of your camera with more parameters as well as allowing remote adjusting of camera settings over NDI®, and is the recommended method of adjusting your camera.

This section explains how to navigate the menus. The menu parameters may vary according to the different product model numbers.

1. To display the main menu, press the MENU button on the supplied infrared remote controller. The main menu is displayed.

OSD
▶ EXPOSURE
WHITE BALANCE
PICTURE 1
PICTURE 2
PAN TILT ZOOM
SYSTEM

2. Use the "↑, ↓" buttons to navigate between main menu items. For example, clicking the "↓" button once will move the cursor to the item below.



OSD	WHITE BALANCE MENU	
EXPOSURE	WB MODE	AUTO
▶ WHITE BALANCE		
PICTURE 1		
PICTURE 2		
PAN TILT ZOOM		
SYSTEM		

3. To enter the sub menu of a selected item, click either the "→" button or the HOME button. In the example below, we are navigating between two sub menus of the Exposure main menu. Sub menu can also be navigated vertically to select sub menu items.

OSD	EXPOSURE MENU: FULL AUTO	
▶ EXPOSURE	MODE	FULL AUTO
WHITE BALANCE	SLOW SHUTTER	OFF
PICTURE 1	S. SHUTTER LIMIT	1/4
PICTURE 2	AE RESPONSE	01
PAN TILT ZOOM	GAIN LIMIT	21.4dB
SYSTEM	EX COMP	OFF

OSD	EXPOSURE MENU: MANUAL	
▶ EXPOSURE	MODE	MANUAL
WHITE BALANCE	GAIN	12dB
PICTURE 1	GAIN LIMIT	21.4dB
PICTURE 2	SPEED	1/60
PAN TILT ZOOM	IRIS	F1.6
SYSTEM	HIGH SENSITIVITY	OFF

4. Once you've navigated to a setting value, use the "←, →" buttons to increment or decrement the value.
5. Press the MENU button to exit the menus.

**NOTE:** When you are operating the menu using the infrared remote controller, you cannot set IR- RECEIVE in the SYSTEM menu to OFF. To set IR- RECEIVE to OFF, use the appropriate VISCA command.



## Camera Menus

### Exposure Menu

The Exposure menu sets items related to exposure.

#### Mode

**Full Auto:** The exposure is adjusted automatically using the value set for EX-COMP.

**Manual:** Allows manual adjustment of the GAIN, shutter speed (SPEED) and iris (IRIS).

**Iris Pri:** Iris Priority mode. This mode allows you to set a fixed IRIS and EX-COMP with exposure achieved by automatic setting of SPEED and GAIN.

**Shutter Pri:** Shutter Priority mode. This mode allows you to set a fixed shutter SPEED and EX-COMP with exposure achieved by automatic setting of IRIS and GAIN.

**Bright:** The bright control function adjusts both gain and iris using an internal algorithm, according to a brightness level freely set by the user. Exposure is controlled by gain when dark, and by iris when bright. As both gain and iris are fixed, this mode is used when exposing at a fixed camera sensitivity. When switching from Full Auto or Shutter Priority Mode to Bright Mode, the current status will be retained for a short period of time.

Below are the various parameters you can adjust for these exposure modes.

#### Gain

Select the gain.

#### Speed

Select the shutter speed.

#### Iris

Select the iris setting.

#### Ex-Comp (Exposure compensation)

When MODE is set to FULL AUTO, SHUTTER PRI or IRIS PRI, setting EX-COMP to ON allows exposure compensation levels to be set.

### White Balance Menu

#### WB Mode (White balance mode)

**Auto:** This mode computes the white balance value output using color information from the entire frame with a range of values from 2500K to 7500K. This mode is the default setting.

**Indoor:** Sets the color temperature to 3200K.

**Outdoor:** Sets the color temperature to 5800K.

**OPW (One push white balance):** The One Push White Balance mode is a fixed white balance mode that may be automatically readjusted only at the request of the user (One Push Trigger), assuming that a white subject, in correct lighting conditions can occupying more than 1/2 of the image. One Push White Balance data is lost when the power is turned off. If the power is turned off, you'll need to reset One Push White Balance.

To select OPW:

1. Place a white subject (i.e., sheet of white paper) in the center of the frame.
2. Press the remote controller HOME button to activate the one-push white balance adjustment.



**ATW (Auto tracking white balance):** Auto Tracking White balance (2000K to 10000K), allows the camera to adjust the white balance according to the temperature of the light source illuminating the subject.

**User:** This is a mode that enables you to manually set the control of Red and Blue gain up to 256 steps.

**Manual:** Allows manual setting of the color temperature.

## Picture 1 Menu

### Sharpness

Adjusts the picture sharpness.

### Effect (Picture Effect)

Select from Monochrome Image (ON) or Color image (Off).

### Noise Reduction

Can reduce the level of image noise.

### Flip

Flips the image upside down for ceiling mounted cameras. Select from upright mode (OFF) or ceiling mount (ON).

### Mirror

Displays a mirror image of the video image.

### De-flicker

Turning this on can help reduce the image flicker that can occur if the camera frame rate is different to the frequency of the local electricity supply that is powering the scene lighting.

## Picture 2 Menu

### Gamma

Adjusts the gamma of the image.

### WDR (Wide dynamic range mode)

The WDR feature is available on certain product models. The camera adjusts the image brightness for both the extreme dark and bright areas of the image.

### Saturation

Adjusts the color saturation.

### Contrast

Adjust the contrast level. The smaller the value lowers the contrast.

### Hue

Adjusts the color phase.

### Color Matrix

Adjusts of hue and gain for magenta, red, yellow, green, cyan and blue.

## Pan Tilt Zoom Menu

### Digital Zoom

When set to OFF, digital zoom does not operate, and only optical zoom is available. When set to ON, 12X digital zoom is activated and digital zoom takes over after optical zoom reaches its MAX.



### Zoom Ratio OSD

Determines whether the zoom ratio displays on screen.

### Video Parameters

When set to ON, the value of the settings will be displayed on screen when you use remote controller to adjust the camera image parameters using the direct adjust buttons "+" or "-" with the feature keys on the remote controller.

### Adaptive P/T

When set to ON, P/T speed are adaptive to the zoom range. For example, the higher zoom ratio you use, the slower the speed of P/T.

### MF Speed

Choose between eight manual focus speeds.

### P/T Speed

Adjusts the speed that the camera pans and tilts when it is controlled using the remote controller.

### Preset Speed

Set the preset recall movement speed.

### Pan Dir

Camera horizontal Left and right orientation setting. Options are Normal or Invert.

### Tilt Dir

Camera tilt up and down orientation setting. Options are Normal or Invert.

## System Menu

### Pelco ID

When using RS485 (PELCO P/D) control, set Camera ID to the controlled address. This value is from 001-255.

### IR-Receive (Infrared Signal Reception)

When this is set to OFF, the camera does not receive the signal from the infrared remote controller. Be sure to keep it set to ON when you use the infrared remote controller. Note that you cannot set IR-RECEIVE to OFF when you operate the menu using the infrared remote controller. To set it to OFF, use the appropriate VISCA controller.

### Display Info

When this item is set to ON, the camera configuration is displayed for approx. 3 seconds on the screen when the camera is powered on or rebooted.

### Audio

Set to ON to enable camera MIC / Audio IN to capture an audio signal source. This item is set to OFF by default.

### Preset Memory

This feature allows you to save the image parameters to PRESET memory. Parameters such as picture, white balance, exposure, focus mode, zoom positions can be saved with the preset.

### Factory Reset

Select this item to set camera back to the factory default setting. Press the HOME button on the remote control to confirm. All user settings for the camera will be deleted.

### Reload Preset 1

When set to ON, preset 1 is set to the Home position. The camera will move to the Home position when it is powered on or reset.



## Video Format

You can change the camera video format. Select VIDEO FORMAT, press the “←” button to choose the video format, then press “→” (Pressing “→” button changes the value on some product models) or HOME button to confirm. After confirmation, press the HOME button again to restore it. The camera will reboot by itself and the new video format is activated.

- You can cancel by pressing the MENU button.
- Depending on the video client software you are using, some video software may need to be restarted to obtain the new video format.

**NOTE:** The camera video format can also be changed by setting the rotary DIP switch at the back of the unit.

## SV (Software Version)

Software Version that is currently running on the camera, you may need this information for technical support.

# Controlling the Camera with the Remote Controller

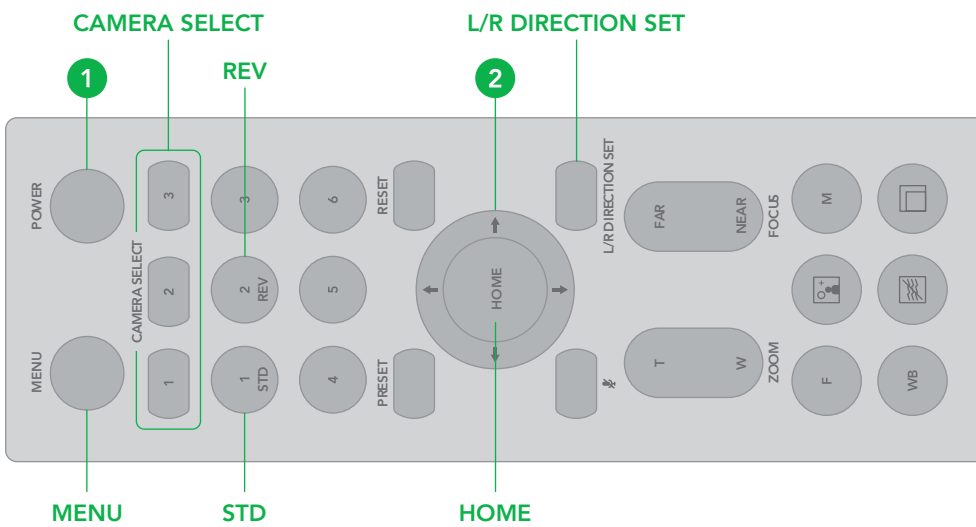

## Panning and Tilting

1. Press the POWER switch. The camera will turn on and perform the pan/tilt reset operation automatically.
2. Press the arrow button to pan or tilt the camera. While checking the picture on the screen, press the desired arrow button.
3. To move the camera in short increments, press the button.
4. To move the camera in long increments, press and hold the button.
5. To move the camera diagonally, press the “← or →” button while holding down the “↑ or ↓” button.
6. Press the HOME button to return to the starting position
7. If the camera moves in a different direction from the one that you intended, be aware that the camera is set so that the image output from the camera is rotated toward the right whenever you press the “→” button.





To set the remote to move the camera toward the opposite direction from that of the button you pressed, press the 2 (REV) button while holding down the L/R DIRECTION SET button.

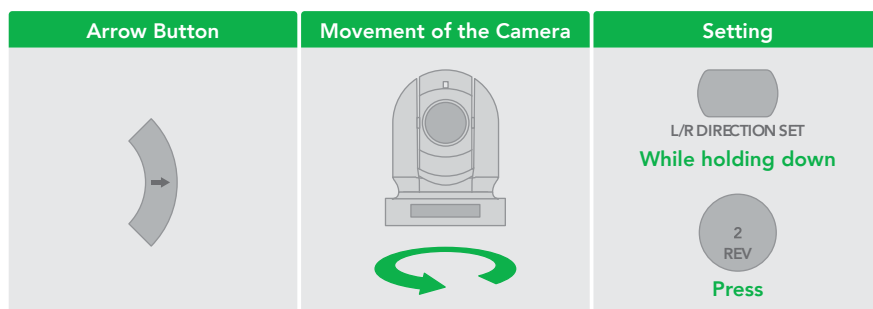

**NOTE:** The above setting only changes the signal emitted from the infrared remote controller, and does not change the setting of the camera itself. Therefore, repeat the setting for each infrared remote controller if you are using more than one infrared remote controller.

A blinking STANDBY lamp may indicate physical interference with the camera movement, and the camera may fail to memorize the pan/tilt position. In this case, press the PAN-TILT RESET button to reset the pan/tilt position.

## Zooming

Button [T]: Zoom In.

Button [W]: Zoom Out.

Button [F]: Fast / Slow toggle.

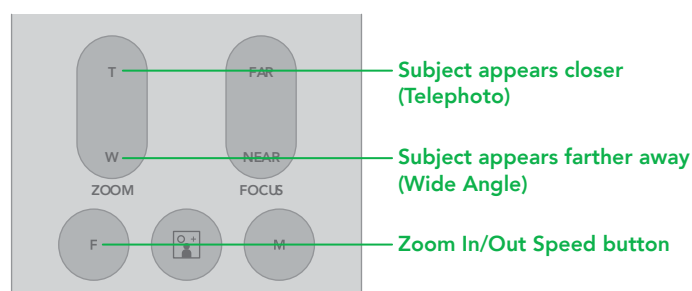

## Focusing

Focusing the camera on a subject automatically  
Press the AUTO button. The camera focuses on the subject at the center of the screen automatically.

### Focusing the camera on a subject manually

After pressing the MANUAL button, press either the FAR or the NEAR button to have the camera focus on the subject.

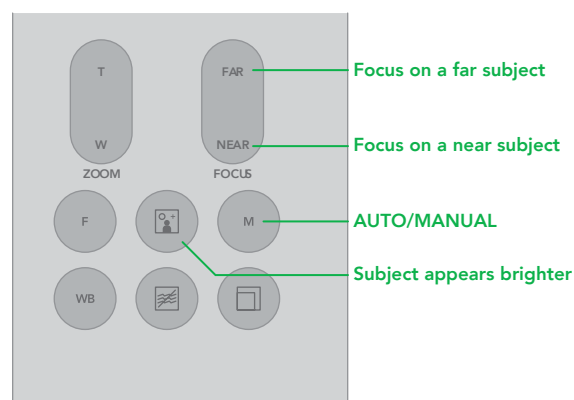

## Shooting with Back Lighting

When you shoot a subject with a light source behind it, the subject becomes dark. In such a case, press the BACK LIGHT button. To cancel the function, press the BACK LIGHT button again.

**NOTE:** The BACK LIGHT function is effective if MODE is set to FULL AUTO in the EXPOSURE menu of the camera.



## Changing Resolution

1. Press the RESOLUTION button.
2. Use the arrow keys to navigate the displayed menu.
3. Press Home to select.
4. Screen will display 'CHANGING...'
5. Press Menu to exit.

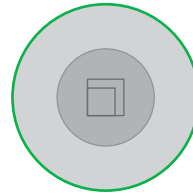

## Storing the Camera Settings in Memory Using Presets

Using the preset function, six sets of camera shooting conditions can be stored and recalled. The six sets of camera shooting conditions can be stored and recalled by using remote controller. Up to 128 presets via protocol programming.

This function allows you to achieve the desired status instantly, even without adjusting the following items each time.

- Pan/Tilt Position
- Zoom Position
- Focus Auto/Manual
- Focus Position
- AE Mode
- Shutter control parameters
- Bright Control
- Iris control parameters
- Gain control parameters
- Exposure Compensation On/Off
- Exposure Level
- Backlight Compensation On/Off
- White Balance Mode
- R/B Gain
- Aperture Control
- WD Parameter

The settings stored using this function are recalled when the power is turned on.

1. Press the RESET button to reset the pan/tilt position.
2. Adjust the position, zooming, focusing and backlighting of the camera.
3. While holding down the PRESET button, press any of the POSITION buttons, 1 to 6, in which you want to store the settings.

### Recalling the stored settings

Press any of the POSITION buttons, 1 to 6, in which you have stored the settings.

### Cancelling the preset memory

While holding down the RESET button, press the POSITION button from which you want to cancel the settings.

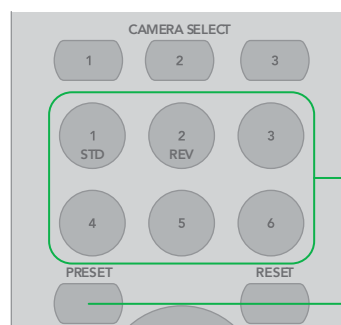

Press a POSITION button

While holding down PRESET Button



**NOTE:**

- When the power is turned on, the camera starts with the settings stored in POSITION 1, so if you want to retain the previous pan and tilt positions, store those positions in POSITION 1.
- When you are storing or cancelling the settings in one POSITION, you cannot call up, store or cancel the settings in another POSITION.
- When the menu is displayed on the screen, you cannot perform the operation for storing, recalling, or cancelling the setting. Be sure to return to the normal display before starting these operations.

## Operating Multiple Cameras with the Infrared Remote Controller

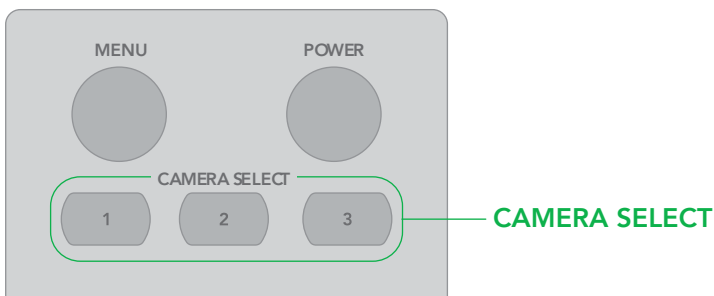

1. Using the DIP switch on the base of the camera, assign a number to the camera (1, 2 or 3).
2. Press the CAMERA SELECT button on the infrared remote controller that corresponds to the number set in step 1.
3. You can now operate the camera(s) specified by number. Every time you operate the camera(s) using the infrared remote controller, the CAMERA SELECT button pressed in step 2 illuminates.



## Web Configuration Panel

The web configuration panel (BirdUI) offers remote access to the settings of the P120. It also allows you to apply firmware updates to your camera.

### Access via a web browser (URL)

The P120 is configured to automatically receive a network IP address from the computer network via DHCP (Dynamic Host Configuration Protocol). Most corporate, education and home networks have a DHCP server present on the network to allow this to occur. Usually your Internet Router provides this.

If the P120 receives an IP address automatically from this server (DHCP), the IP address can be discovered in several ways, including BirdDog Central Lite software available from [here](#).

**NOTE:** Your computer will need to have 'Bonjour' services loaded in order to access the unit via its user defined name. Apple devices come pre-installed with Bonjour, while Windows devices need a plugin available from [here](#).

### Accessing the P120 on a network without a DHCP server

Some standalone or private networks may not have a DHCP server. After 30 seconds of waiting for an automatically assigned IP address, the P120 will reassign to the designated fallback address (the default is 192.168.100.100).

In order to access the BirdUI on a network which is configured to a different subnet, change your computer's IP address to match the BirdDog unit. Once you gain access to the BirdUI, choose your IP address to match the rest of the devices on your network.

For instructions on setting your computer's IP address, please consult your computer operating system manual or IT support resources.

## Password Management

Once you direct your web browser to the BirdUI you will be presented with the Dashboard. To make changes to any settings, you'll need to log in.

### Default Password

The BirdUI is secured by a user-selectable password. The default password is: **birddog** (one word, lower case).

### Password Reset

To change the password simply login using the default password, navigate to the Network tab in the BirdUI, and select Change Password.

It is recommended to change this password in a network environment where the P120 is shared with other users (e.g. not private). By entering this password, the user is granted full access to the P120 configuration settings and could interrupt a live program.

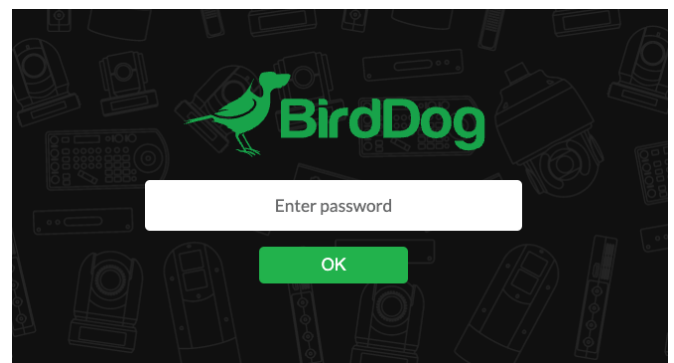



# BirdUI Layout

The BirdUI is organized into the following panels:

## 1. Dashboard

Overall view of important information such as the network connection type and video stream format and resolution.

## 2. Network

General network settings such as DHCP IP Address details, timeout fallback address and camera network name, as well as NDI® specific network settings

## 3. System

System admin functions such as updates, password change, designation of group access and camera reboot.

## 4. AV Setup

Full NDI® encode management and audio settings.

## 5. CamControl

Exposure, white balance, picture and color settings.

## 6. Scopes

Settings for the Histogram, Waveform, RGB Parade and Vectorscope.

## 7. Logout

BirdUI logout.

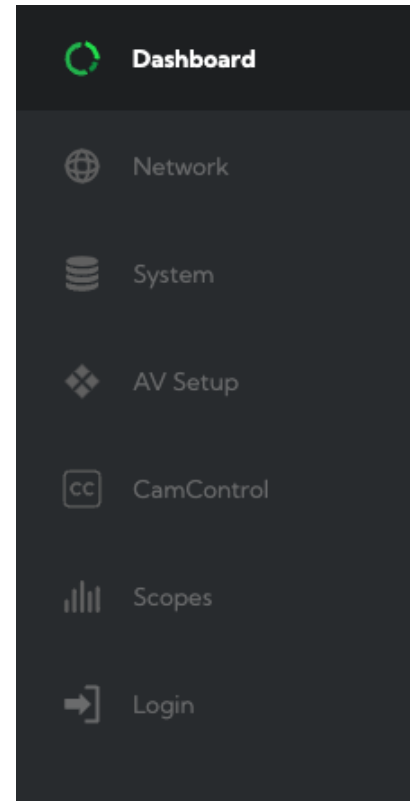



# Dashboard

The Dashboard displays an overall view of important information.

## 1. CPU Usage

Current computer system CPU utilization.

## 2. Device mode

Encode or Decode. For a camera this is fixed at Decode.

## 3. Network Bandwidth

Network bandwidth consumption of the current NDI® output stream(s).

## 4. Status

- a. NDI video stream name
- b. Selected video format.
- c. NDI audio status.

## 5. Stream Info

- a. Video resolution, frame rate and sample rate.
- b. Number of audio channels of the camera. The audio output sample rate and average NDI® bitrate of the camera.
- c. Genlock status, and network transmit method.

## 6. System Details.

- a. Camera name.
- b. Network details, including IP address and network configuration method (DHCP or Static).
- c. Online status of the camera.
- d. MAC address and current firmware version of the camera.

## 7. Device Restart

Click this button to restart the NDI® stream. This may be necessary after changing key image settings e.g., resolution.

## 8. System Reboot

Click this button to reboot the unit after changing key network settings or the BirdDog name.

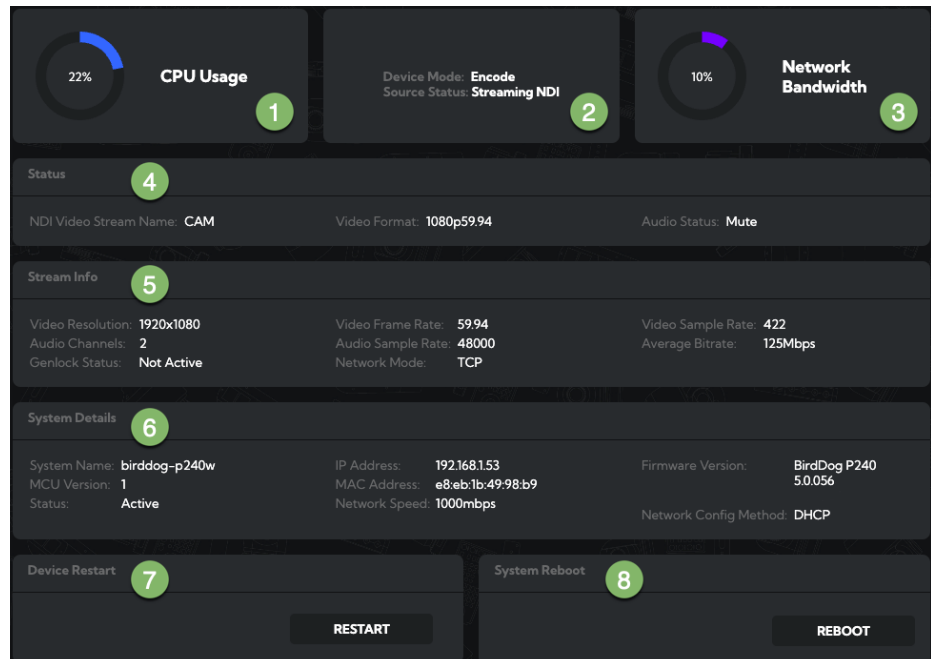



## Network

### Network Details

Most computer networks provide for both automatic and manual configuration of network devices and the P120 can accommodate both.

#### Configuration Method

Here you can set the network configuration to either DHCP (default) or Static. DHCP simplifies the management of IP addresses on networks. No two hosts can have the same IP address, so assigning them manually can potentially lead to errors. If your network is set up for DHCP, this is generally the best configuration to choose.

If you do choose to go with a Static IP address, you'll need to add the IP Address, Subnet Mask and Gateway Address information according to the requirements of your network.

Network Details				
Configuration Method	<input type="radio"/> STATIC	<input checked="" type="radio"/> DHCP	DHCP Timeout	20
IP Address	192.168.2.132		DHCP Fallback IP Address	192.168.100.100
Subnet Mask	255.255.255.0		DHCP Fallback Subnet Mask	255.255.255.0
Gateway Address	192.168.2.1		BirdDog Name	zoom-p120.local
				<b>APPLY</b>

#### DHCP Timeout, Fallback IP address, Fallback Subnet Mask

You can set the timeout period during which the P120 will look for a DHCP IP address. After this period, the camera will default to the designated fallback IP address.

This can be useful if you use your camera in other network environments. For example, if a DHCP server is available in your normal office or studio application, the camera will use the DHCP supplied IP address. If you then use the camera in another application without a DHCP server, your camera will always default to the known fallback IP address. NOTE: Do not set the fallback IP address the same as the camera IP address. It is recommended to keep the fallback IP address.

#### BirdDog Name

You can give your camera a meaningful name to make identification easier when viewing NDI® sources on a receiver such as a TriCaster, vMix or Studio Monitor. Be sure to make the name unique, as no two devices on the network should have the same name. The name can be any combination of a-z, 0-9, and '- '.

After renaming your camera, navigate back to the System menu and click the REBOOT button. The camera will re-initialize and you'll be good to go.

### NDI Network Settings

The P120 operates with the latest NDI® Libraries. There are several options to configure the P120 behavior in an NDI® network. Each configuration has its benefits, however it is recommended to utilize the default TCP transmit method unless you have reason to change.



**NDI Network Settings**

NOTE: Changing of NDI network settings can have a major impact on system compatibility and performance across your network. You should carefully consider the need to change these settings. Consult the user guide for more details.

Transmit Preferred Method	TCP	NDI Discovery Server	OFF	ON
Multicast Net Prefix	239.255.0.0	NDI Discovery Server IP Address	192.168.2.100	
Multicast Net Mask	255.255.0.0			
Multicast TTL	1			

APPLY

## Preferred Transmit Method

### TCP

TCP is the default method of transmission for NDI®. It operates well within local networks with predictable latency and limited jitter. BirdDog recommends that TCP be used for typical applications, and only using alternative transports for specific reasons.

### UDP

UDP is recommended for networks where there is extended latency from one end to the other. The nature of UDP means that it does not receive a confirmation of each packet being successfully received – vastly improving performance on busy networks. UDP can have some consequences if there are other issues on the network such as jitter or lost packets as it will not inherently re-resent a lost packet.

### R-UDP (Reliable UDP)

This protocol bridges the performance of TCP and UDP. Compared to TCP, it reduces overall network load (allowing more NDI® streams) by not requiring every packet to be 'acknowledged' by every receiver – has error correction built in for smoothness and reliability.

### Multicast

Multicast is especially useful for use-cases that require a single source to be received on multiple receivers simultaneously. Utilizing Multicast offloads the distribution of the NDI® A/V packets from the P120 to the network infrastructure. You should take care to ensure your network is specifically configured to support Multicast as using it on an ill-prepared network can create unintended network problems.

## NDI Discovery

If you choose to use a NDI® discovery server, you can configure it in this tab. By default, NDI® utilizes mDNS (multicast Domain Name System) to create the zero configuration environment for discovery. Unless the network is specifically configured to not allow mDNS, NDI® sources will be discovered.

The NDI® discovery service is designed to replace the automatic discovery NDI® uses with a server that operates as an efficient centralized registry of NDI® sources that requires much less bandwidth. Multiple servers can be specified for failover redundancy. NDI® discovery server also helps with location of devices that reside on different subnets. The NDI® Discovery Server is available in the free [NDI SDK](#).

1. If you are using one or more NDI® Discovery Servers, click the ON button.
2. Enter a comma delimited list of the IP address(es) of your NDI® Discovery Server(s).
3. Click the APPLY button to save your changes.





## System

### Password Settings

A screenshot of the 'Password Settings' interface. It features a dark background with white text. At the top left, it says 'Password Settings' with a three-dot menu icon to its right. Below this, there are three input fields: 'Current Password', 'New Password', and 'Confirm Password'. Each field has a small eye icon to its right, indicating a toggle for password visibility. To the right of the 'Confirm Password' field is a green button with the text 'APPLY' in white.

The BirdUI is secured by a user-selectable password. To make changes to any settings, you'll need to log in. The default password is **birddog** (one word, lower case). It is recommended that the default password be changed, since the BirdUI grants full access to the camera configuration settings.

You can change the password in the Password Settings tab.

1. Enter the current password.
2. Enter the new password. It is recommended that you change this password to retain administration rights to prevent unauthorized changes in a network environment where PTZ Keyboard is shared with other users (e.g. not private). Confirm the new password and click the APPLY button.

### System Update

A screenshot of the 'System Update' interface. It features a dark background with white text. At the top left, it says 'System Update' with a three-dot menu icon to its right. Below this, there is a 'CHOOSE FILE...' button with a vertical ellipsis icon to its right. Below the button is a green button with the text 'UPDATE' in white.

We are always adding new features and improving the performance of our products, so installing the latest firmware will provide you with the best user experience.

To upgrade the firmware, [download the firmware](#) and follow the **Firmware Upgrade Instructions** located in the download folder.



## Access Manager Configuration

### Remote IP List

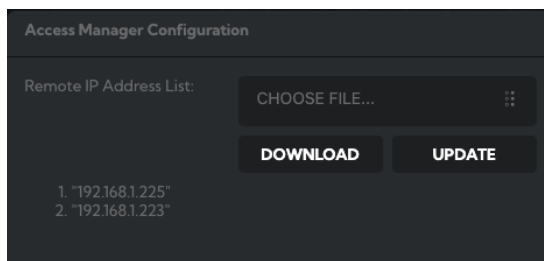

By default, NDI® devices are visible to each other only when they're on the same VLAN. If you want visibility or control of a device on a different VLAN, you need to add its address manually as a Remote IP. You can upload and download Remote IP Lists for sharing with other cameras. To upload a list:

1. Click the CHOOSE FILE button to load your Remote IP List in UTF-8 encoded string format.
2. Click the UPDATE button. Do not upload a blank list.

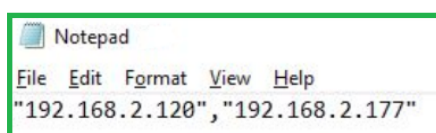

### NDI Group List

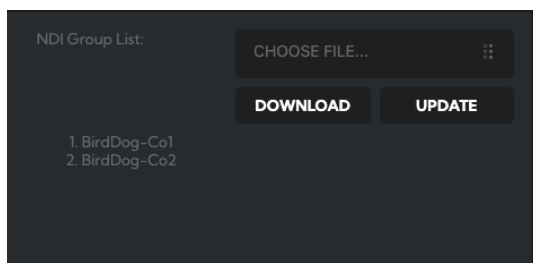

Set the NDI® group list. NDI® groups allow you to restrict communication to only devices that belong to the same NDI® group. NDI® Groups can be very useful in larger environments to control visibility and access amongst various groups. You can upload and download group lists for sharing with other cameras. Groups also need setting up in NDI Access Manager, available in [NDI Tools](#).

To upload a list:

1. Click the CHOOSE FILE button to load your NDI® Group List in UTF-8 encoded string format.
2. Click the UPDATE button. Do not upload a blank list.

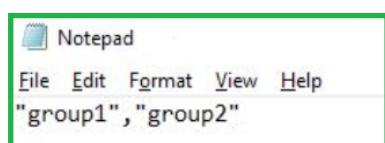

## System Reboot

Click the REBOOT button to perform a camera reboot.



# AV Setup

## Device Settings

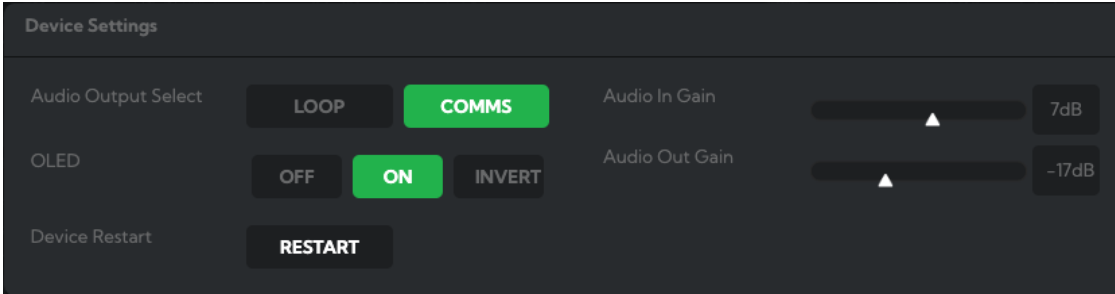

### Audio Output Select

**Loop:** Audio from the Audio In port, for example, from a connected microphone, is directed to the Audio Out port for monitoring.

**Comms:** Audio from NDI® stream is directed to the audio out for camera operator comms. You'll need software such as BirdDog Comms Lite/Pro to use this function.

### Audio In / Out Gain

Controls for adjusting the audio in/out gain.

### OLED

**Off/On:** Enables or disables the camera OLED display.

**Invert:** Inverts the display for use during inverted camera mounting.

### Device Restart

Restarts the NDI® stream. This may be necessary after changing key image settings e.g., resolution.

## NDI Encode Settings

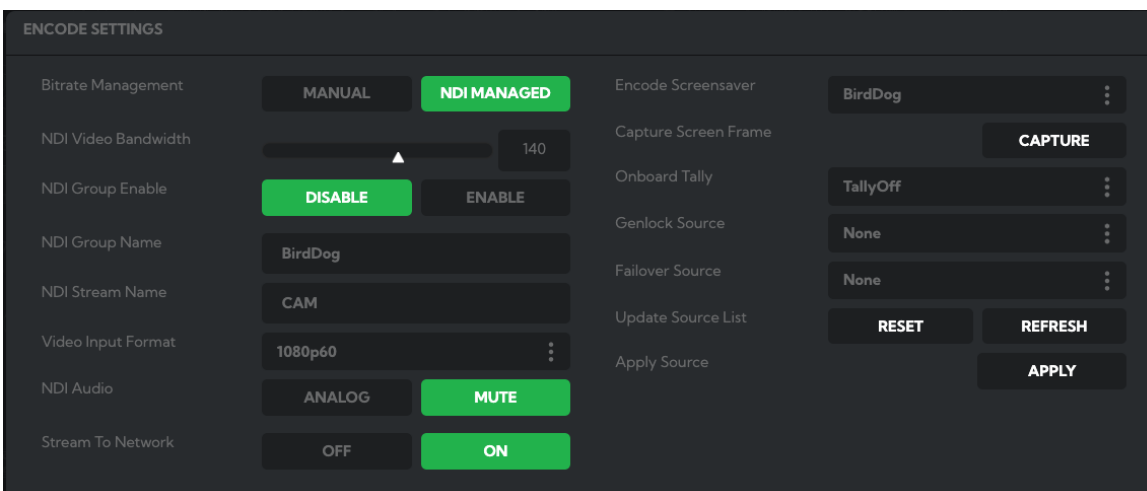

### Bitrate Management

BirdDog Devices allow you to set your target NDI® output bitrate. This allows you to select a compression ratio that is more efficient for your networking infrastructure (lower bandwidth) or higher image quality for critical footage. The scale allows you to select the range of 60 - 360 Mbps.



By setting Bitrate Management to NDI MANAGED, the target bitrate will be set in accordance with the NDI® standard. By selecting MANUAL you are able to manually select a target bitrate. Do this with care, as the actual bitrate may be greater, straining the capacity of the network and the receiving device, and lower settings may result in reduced image quality.

### NDI Groups

NDI® supports **Grouping** which allows you to hide the visibility of video sources to viewers that are not part of the group. If disabled (default), the video source is public and viewable by any receiver on your network. Click on the field and type a group name. Receivers can then scan for, and select your group.

### Stream Name

You can give the camera NDI® output stream a meaningful name to make identification easier on any NDI®-capable receiver, particularly on networks where there are a large number of NDI® streams.

### NDI Video Format

The P120 is capable of outputting independent video formats for both NDI® and SDI/HDMI. This setting affects only the NDI® video output. Please note that the video rate you select here must be of the same family as the SDI/HDMI video output, for example, 720p50 aligns with 1080i50/1080p50 but will not co-exist with any 29.97/30 fps based camera setting.

### NDI Audio

Select MUTE to disable the NDI® audio. Select ANALOG to receive audio from the audio inputs.

### Stream to Network

You can choose to disable the NDI® output stream.

### Encoder Screensaver

Assign a captured frame, black frame, or BirdDog logo as a screensaver.

### Capture Screensaver Frame

Click the CAPTURE button to capture the current frame for use as a screensaver.

### Onboard Tally

Enable the camera Tally light.

### Genlock Source

Select the NDI® genlock source from the dropdown list.

### NDI Failover Source

NDI® has a failover function where you can designate an alternate camera or NDI® source for the receiver, should this camera become disconnected or otherwise unavailable on the network. Click on the Available NDI Sources field to select your alternate source.

### Update Source List

Pressing the REFRESH button will add new sources to the list, whereas pressing the RESET button will populate the list with only active NDI® sources. Click the APPLY button to apply your failover source change.



## CamControl

### Camera Control Tab

#### Menu On / Off

To adjust cameras settings via the OSD (On Screen Display), click the Menu ON/OFF button.

The OSD is visible on both the NDI® output and SDI/HDMI, and can also be accessed via the included remote control. Since it uses the same controls for menu navigation, PTZ control of the camera movement will not be possible until the OSD menu is closed again.

#### Zoom

Click the TELE button to zoom in and the WIDE button to zoom out.

#### Focus Mode

Select between Auto and Manual focus modes.

#### Focus

Click the IN button to focus on nearer subjects and the OUT button to focus on subjects further from the camera.

#### Pan / Tilt / Zoom Speed

When controlling the P120 over NDI® you can individually set the maximum speed of PTZ movements. Higher numbers produce faster and more sensitive movements of the camera.

#### Image Settings Reset

Click this button to reset all image settings to their factory default.

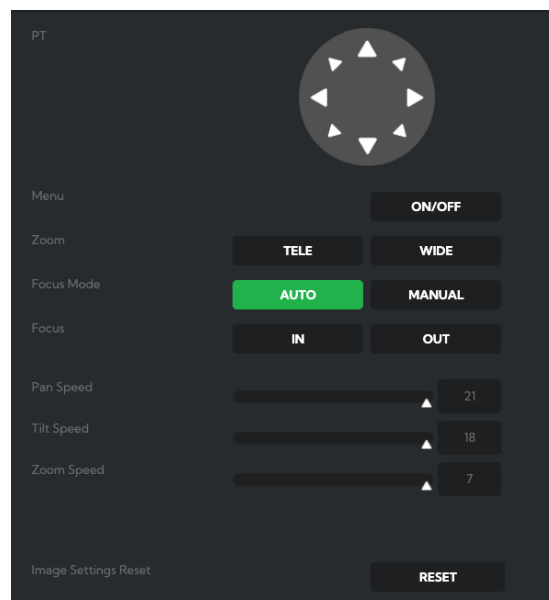

### FreeD Tab

Enable or disable FreeD. FreeD is a protocol for real time camera PTZ position query. Any application that uses FreeD can use this data, usually in a virtual environment, where a physical camera move (i.e. pan, tilt, zoom or iris change) can trigger the virtual environment to follow that move in real time.

#### IP Address / Port

Enter the IP address of the host and the port that the data package will be sent to.

#### Apply FreeD Settings

Click the APPLY button to save your changes.

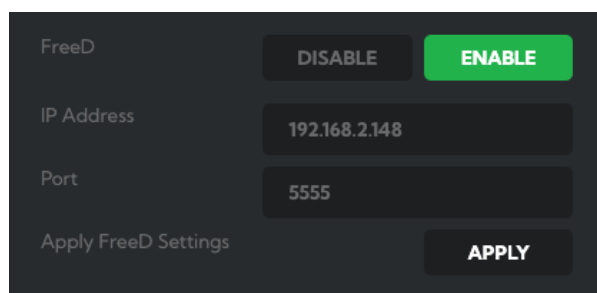

### Preset Tab

To save a Preset select a number, make your desired changes, click the Save button and then click a Preset number. To recall a Preset, click the Preset number. You can save two separate and different types of Presets:

**BirdDog:** Saves only PTZ information with the Preset.

**Camera:** If System/Preset Memory is enabled in the camera Menu via the OSD, image parameters such as picture, white balance, exposure, focus mode, zoom positions will also be saved with the Preset.



## Exposure Tab

### Mode

**Full Auto:** The exposure is adjusted automatically using the values set for EXPOSURE COMPENSATION.

**Manual:** Allows manual adjustment of the GAIN, IRIS and SPEED (shutter speed).

**Shutter Priority:** The shutter speed can be set freely by the user, and the iris and gain are set automatically, according to the brightness of the subject. The exposure is adjusted automatically using the values manually set for SPEED (shutter speed), GAIN and EXPOSURE COMPENSATION.

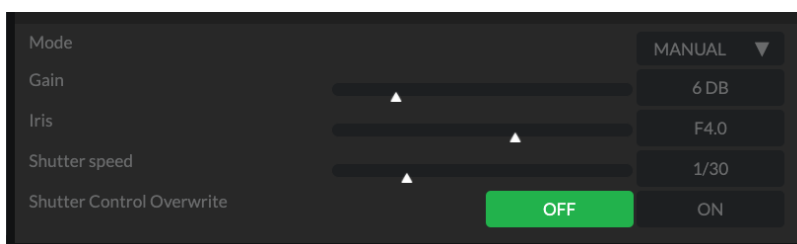

**Iris Priority:** The iris can be set freely by the user. The gain and shutter speed are set automatically according to the brightness of the subject. The exposure is adjusted automatically using the values manually set for SPEED, GAIN and EXPOSURE COMPENSATION.

**Bright:** The bright control adjusts both gain and iris using an internal algorithm, according to a brightness level freely set by the user. Exposure is controlled by gain when dark, and by iris when bright. As both gain and iris are fixed, this mode is used when exposing at a fixed camera sensitivity.

### Gain

Select the gain from 0–30dB.

### Iris

Select the iris from CLOSE – F1.8.

### Shutter Speed

When video format is set to 720P25, 1080P50, 1080i50, 1080P25 or 720P50, shutter speed can be selected from the following:

- 1/1, 1/2, 1/3, 1/6, 1/12, 1/25, 1/50, 1/75, 1/100, 1/120, 1/150, 1/215, 1/300, 1/425, 1/600, 1/1000, 1/1250, 1/1750, 1/2500, 1/3500, 1/6000, 1/10K.

When video format is set to 720P30, 1080i59.94, 1080P29.97, 720P59.94, 1080P59.94, 1080i60, 1080P30, 1080P60 or 720P60, shutter speed can be selected from the following:

- 1/1, 1/2, 1/4, 1/8, 1/15, 1/30, 1/60, 1/90, 1/100, 1/125, 1/180, 1/250, 1/350, 1/500, 1/725, 1/1000, 1/1500, 1/2000, 1/3000, 1/4000, 1/6000, 1/10K.

### Shutter Control Overwrite

You can set an optional shutter speed for use when monitor screens are visible in the camera image. Click the ON button to activate the Shutter Speed Overwrite shutter speed value.

### Exposure Compensation

When MODE is set to FULL AUTO, SHUTTER PRI or IRIS PRI, setting EXPOSURE COMPENSATION to ON allows exposure compensation levels to be set.

## White Balance Tab

### Cam White Balance

**Auto:** This mode computes the white balance value output using color information from the entire frame with a range of values from 2500K to 7500K. This mode is the default setting.

**Indoor:** Sets the color temperature to 3200K.

**Outdoor:** Sets the color temperature to 5800K.

**OPW (One Push White Balance):** The One Push White Balance mode is a fixed white balance mode that may be



automatically readjusted only at the request of the user (One Push Trigger), assuming that a white subject, in correct lighting conditions can occupy more than 1/2 of the image. One Push White Balance data is lost when the power is turned off. If the power is turned off, you'll need to reset One Push White Balance.

To select OPW:

1. Place a white subject (i.e., sheet of white paper) in the center of the frame.
2. Press the remote controller HOME button to activate the one-push white balance adjustment.

**ATW (Auto Tracking White Balance):** Auto Tracking White balance (2000K to 10000K), allows the camera to adjust the white balance according to the temperature of the light source illuminating the subject.

**Manual 1 / Manual 2:** These two user modes allow you to manually set the following color balance parameters.

### Cam Red/Blue Gain

Sets the intensity of red and blue colors in the image.

### Cam Color Temp

Sets the color temperature of the image in degrees Kelvin.

## Picture Tab

### Sharpness

Adjusts the picture sharpness value from 0 to 15.

### Effect

Select from Monochrome Image (B&W) or Color image (OFF).

### Noise Reduction

Can reduce the level of image noise. Select from 6 levels - OFF, 1 - 5 (MAX).

### Flip

Flips the image upside down for ceiling mounted cameras. Select from upright mode (OFF) or ceiling mount (ON).

### Mirror

Displays a mirror image of the video image.

### WDR (Wide dynamic range mode)

The WDR feature is available on certain product models. The camera adjusts the image brightness for both the extreme dark and bright areas of the image.

### Saturation

Adjusts the intensity of colours in the image from a range of 1-15.

### Hue

Adjusts the color phase from 1-15.

### Contrast

You can adjust the contrast level in the range from 0 (00h) to 255 (FFh). The initial setting is 128 (80h). The smaller the value lowers the contrast.

### Gamma

Adjusts the gamma of the image from 0 to 1.

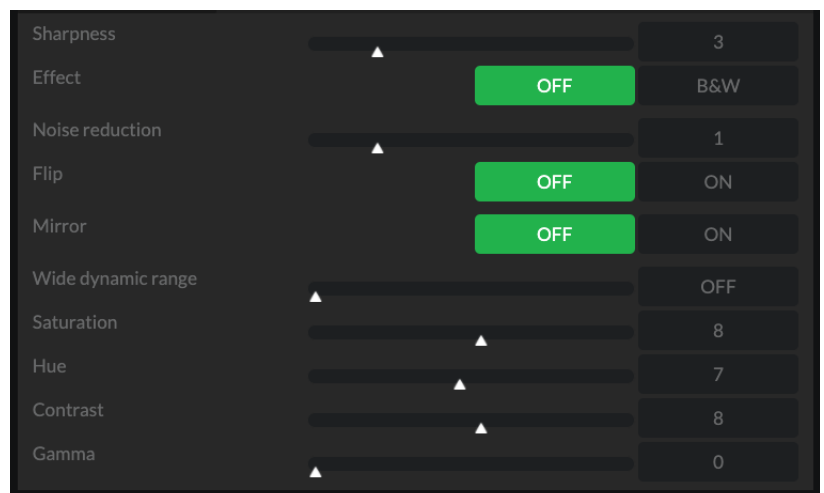



## Colour Matrix Tab

The Color Matrix features 64 levels of adjustment of Gain (Intensity) and Hue (offset) across six color sections, Red, Green, Blue, Cyan, Magenta and Yellow, and allows individual fine-tuning of each of these without affecting the response of other color components.

You can also view an online [video](#) that covers this section.

### Colour Gain

The Gain control of each colour component defines how intense that colour is represented in the image. The default level (32) is a moderate gain which shows an even bias between all pixels that contain the colour. I.e. a dark red with have the red component shown as vividly as a bright red, this generally gives a balanced look to your colour representation.

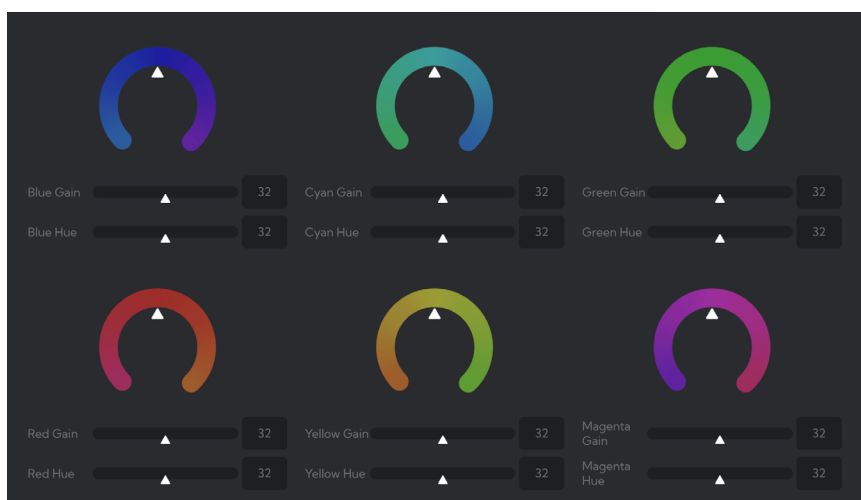

Increasing the gain value will add additional intensity to all parts of the image pertaining to this colour. For example, if you increase the Red gain value to 64 all pixels that are red in the image will have a boost of colour compared to other colours in the image resulting in a more vivid representation of this colour. Conversely reducing the colour gain will take some intensity out of the target colour. This can be useful in some lighting conditions where certain colours appear over saturated to the camera.

Increasing the gain value will add additional intensity to all parts of the image pertaining to this colour. For example, if you increase the Red gain value to 64 all pixels that are red in the image will have a boost of colour compared to other colours in the image resulting in a more vivid representation of this colour.

Conversely reducing the colour gain will take some intensity out of the target colour. This can be useful in some lighting conditions where certain colours appear over saturated to the camera.

### Colour Hue

The Colour Hue option adjusts the temperature or phase in which any colour is represented. When looking at the colour spectrum, beyond the true colour points for each of the main colour adjustments in the camera (Red, Green, Blue, Cyan, Magenta and Yellow there are areas where the colours transition to their neighbouring colour point. The P120 Colour Matrix controls allow you to adjust the colour offset in a negative (counter clockwise) or positive (clockwise) direction, effectively moving the cameras response to any colour towards its neighbouring colour transition point. Adjusting individual colour Hue can assist dramatically in matching colour representation from the camera to true-to like colours or matching the P120 to other cameras in your production.

### Using a Colour Chart

It is recommended to utilise a colour chart or colour chip chart when adjusting the Colour Matrix controls. These charts are available readily and have colour chips for each of the colours that the camera can adjust. By utilising a colour chip chart you are more easily able to see the impact of any adjustment you are making.

Using a colour chip chart such as the Datacolor SpyderCheckr can be beneficial to fine-tuning adjustments in the P120 Colour Matrix.

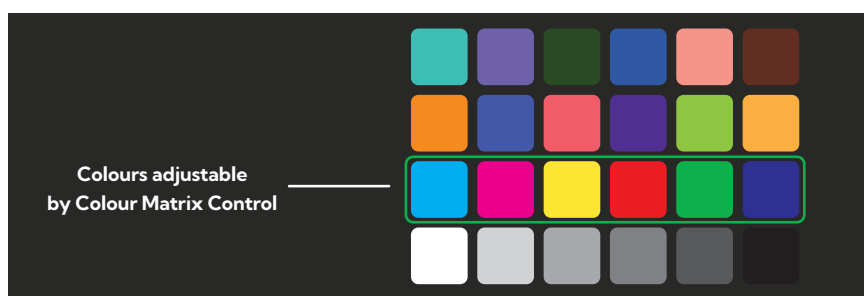





## Scopes

Since there is variation in both the eyesight of individuals and video monitors, Cam Control offers NDI® video scopes to assist in evaluating the color and tonal qualities of your image.

**Program / Preview Enable:** Choose to overlay the scopes on either the program output, the preview output or both.

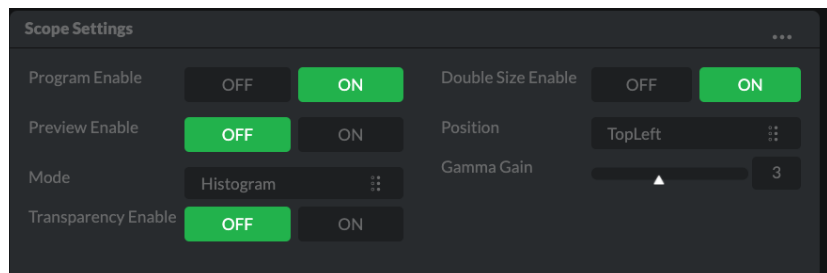

**Transparency Enable:** Click the ON button to enable scope transparency, allowing the video image to be visible behind the scopes.

**Double Size Enable:** Click the ON button to select the large scope size.

**Position:** Selects the position of the overlaid scope on the video image. Select from Top Left, Top Right, Bottom Left and Bottom Right.

**Gamma Gain:** Adjusts the brightness of the displayed scopes.

### Mode

**Histogram:** The Histogram shows the distribution of luminance (brightness) in the image, from darker pixels on the left of the scope, to brighter pixels on the right. The height of the curve is a measure of the number of pixels in the image with a particular luminance value. Unlike the Waveform or RGB Parade scope, the Histogram does not indicate the left to right physical position of the luminance values in the image.

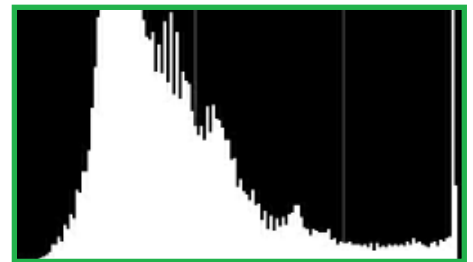

**Waveform:** The Waveform scope shows the distribution of luminance in the image as a waveform that ranges from zero at the lower horizontal line, to 100 % intensity at the upper horizontal line. The left to right position of the values match their position in the image.

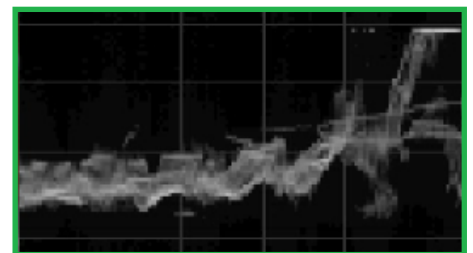

**RGB Parade:** The RGB Parade shows the intensity of Red, Green and Blue in the image as separate waveforms that ranges from zero at the lower horizontal line, to 100 % intensity at the upper horizontal line. For each waveform, the left to right position of the values match their position in the image.

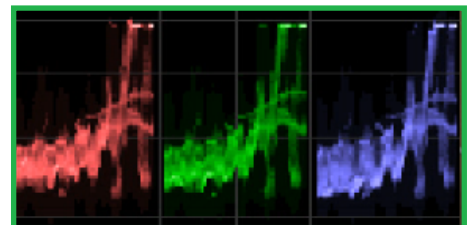

**Vector:** The Vectorscope is a circular graph that displays the chrominance (hue and saturation) of the image colors. The distance from the center indicates the degree of color saturation, from zero intensity at the center of the circle, to 100% intensity at the edge of the circle.

The graph is divided into color segments, each indicated by the colored perimeter of the circle, showing the dispersion of color in the image. A Waveform scope is also displayed on the left side of the Vectorscope.

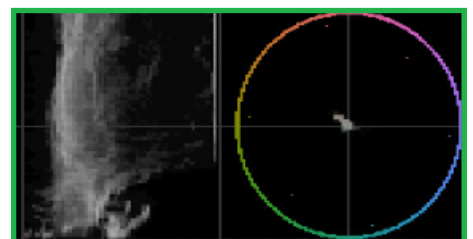



## Receiving NDI® Video

There are many applications that support receiving the NDI® signal that the P120 produces. Each application will vary slightly on how you choose your source.

### NewTek Studio Monitor

NDI® Tools is a free suite of applications designed to introduce you to the world of IP video and is available [here](#).

The included Studio Monitor application allows you to monitor many NDI® sources on a standard Windows computer. Once Studio Monitor is launched on your computer, simply right click anywhere in the interface and select your camera from the dropdown list.

Once connected to the P120, a gear icon is displayed on the bottom right-hand side of the video display providing shortcut access the P120 BirdUI.

### NewTek TriCaster Series

NewTek TriCaster series devices allow several NDI® sources to be received simultaneously, the amount of simultaneous connections varies by what model TriCaster you have. Consult your TriCaster user manual to determine how many connections are available on your device.

To select the P120 as a source on your TriCaster, click on the configuration gear icon below your desired source location which will then display the Input Setting dialog. Select your P120 source from the dropdown list.

Once connected to the P120, a configuration gear icon displays next to the source dropdown window that provides shortcut access the P120 BirdUI.



## NDI® Camera Control

The easiest way to control your camera is via the BirdDog PTZ Keyboard!

BirdDog PTZ Keyboard supports NDI®, NDI®|HX, Visca over IP, RS422, and RS232. By harnessing BirdDog's next generation NDI® and IP technology, it's never been easier to discover, connect, and control your PTZ cameras.

### IP Connection

#### IP Port to Network Switch

1. Connect the camera NDI® Ethernet port to a port in a Ethernet switch on your network. The switch must provide PoE+ if you are not using the power adaptor.
2. Connect the PTZ Keyboard's IP port to a port on the Ethernet switch (or other connected switch on the same network subnet).
3. [Login](#) to the web interface (BirdUI) of the camera and PTZ Keyboard to configure the appropriate settings.

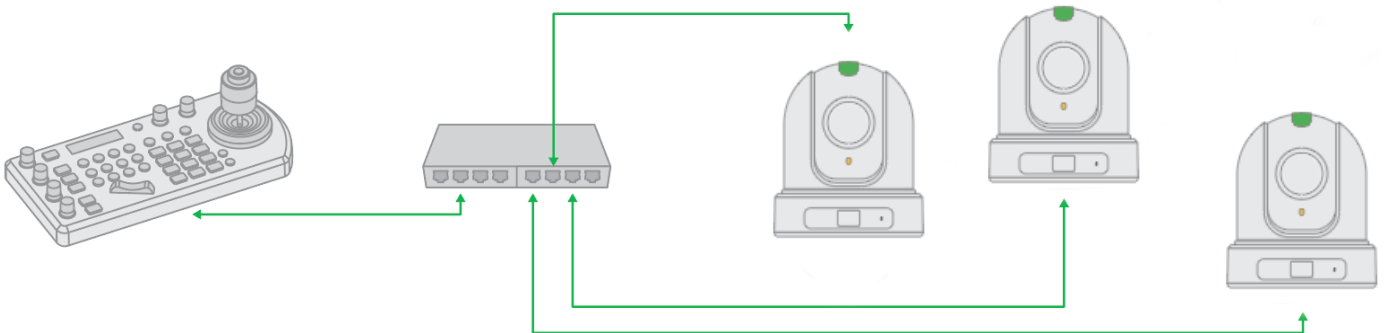

### Remote Controller

You can use the supplied remote controller to control your camera. For instructions on use, please refer [here](#).



## Controlling Your Camera Via Other Protocols

The P120 also supports control via VISCA-over-IP, RS-232 and RS-422/485. This section details how to configure control under these protocols.

When the camera is connected to a computer and joystick keyboard with a VISCA cable (cross type, RS-232), you can operate the camera with the computer and the joystick keyboard.

When the camera is connected to a joystick keyboard a control cable (cross type, RS-422/485), you can operate the camera's pan, tilt, zoom with the joystick keyboard.

In this connection configuration, a HDMI cable, SDI video cable, data cable and network cable is required. To obtain these third-party components or accessories, consult the dealer where you bought your camera.

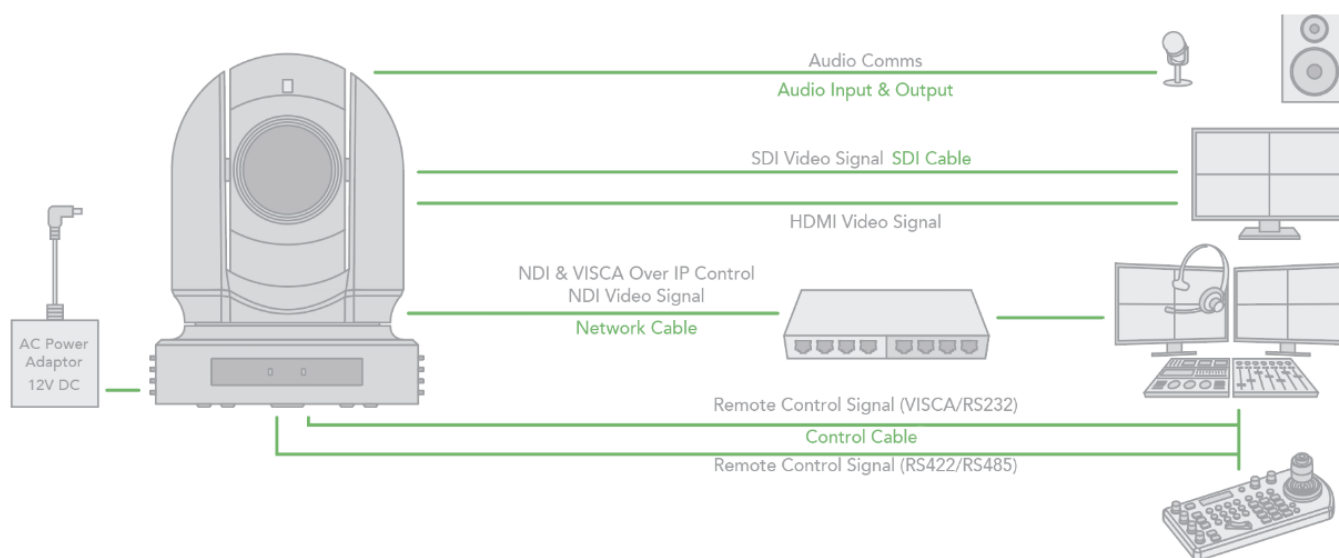

## Camera Initial Setting Status Information

Upon bootup, the following information of the camera initial setting status will display on the monitor for 5 seconds.

1. Camera PELCO ID for RS-485 control.
2. Camera ID for IR Remote Controller.
3. IR remote control signal receive current setting.
4. Baud Rate current setting.
5. Control COMM Port current setting.
6. Video format current setting.
7. HDMI current setting.
8. Model number.
9. Firmware version.

CAMERA STATUS INFO DISPLAY	
PELCO ID	001
IR ID	01
IR-RECEIVE	ON
BAUD RATE	9600
COMM TYPE	422
FORMAT	1080p29.97
HDMI OUT	YUV
MODEL TYPE	EYES P200
SV	V0B1100S36[...]



## VISCA over IP Control

With VISCA over IP, you can control the camera using the VISCA protocol on a controller equipped with IP communication capabilities via LAN.

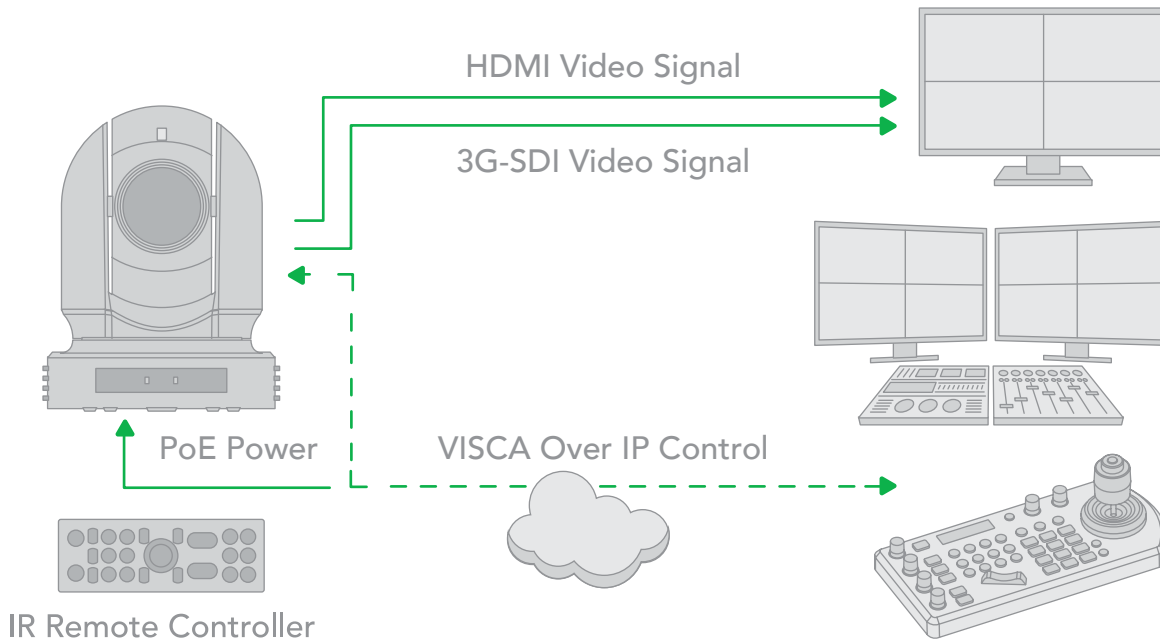

### VISCA over IP communication specifications:

- Interface: RJ-45 10 / 100 / 1000 Mbps
- Interface protocol: IPv4
- Transport protocol: UDP
- IP address: 192.168.100.100 By default
- Port: 52381

### Controlling via VISCA over IP

1. Connect the network port on the camera to the network switch.
2. Set the IP address and other network information appropriately to communicate on your network.
3. Connect the VISCA over IP compatible controller to the network.
4. Configure the controller to access the camera's IP address and VISCA over the IP port.
5. The IP port within on your control must be set to 52381 to communicate with the camera.
6. Select the VISCA protocol on your IP control device.



## Setting the DIP Switch

The camera DIP switch are located on the camera base. Turn off power to the camera before changing the DIP switch settings. Power on the camera to have the new DIP switch setting activated.

**NOTE:** The camera OSD and DIP settings override each other. Whichever was the last to be changed will be used by the camera when it boots.

### Switch 1 (left side switch in the orientation below)

Default Setting: ON, OFF, OFF, OFF, OFF, OFF, OFF, ON.

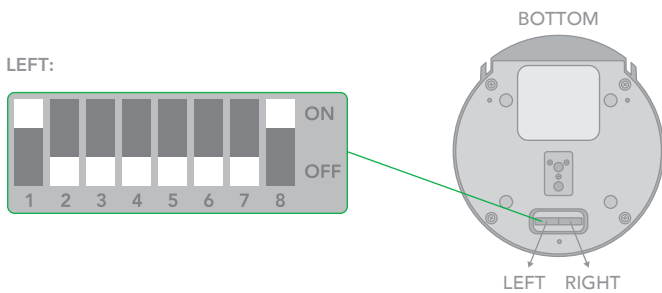

#### 1. Bit 1~3: Camera Address setting for VISCA protocol

1	2	3	VISCA Address
ON	OFF	OFF	1
OFF	ON	OFF	2
ON	ON	OFF	3
OFF	OFF	ON	4
ON	OFF	ON	5
OFF	ON	ON	6
ON	ON	ON	7

#### 2. Bit 4: Video Output/Video Color Space

When using HDMI output to display on HDMI device, set the DIP switch B4 to OFF. When using HDMI to DVI converter to have DVI video output, set the DIP switch B4 to ON.

4	Colour Space Setting
OFF	YUV Output
ON	RGB Output

#### 3. Bit 5: Reserved

#### 4. Bit 6: RS-232/RS-422

6	Control Mode
OFF	RS-232
ON	RS-422



5. Bit 7~8: RS-232/RS-422 Baud Rate

7	8	Baud Rate Setting
OFF	OFF	2400 bps
ON	OFF	4800 bps
OFF	ON	9600 bps (Default)
ON	ON	38400 bps

Switch 2 (right side switch in the orientation below)

Default Setting: OFF, OFF, OFF, ON, OFF, OFF, OFF, OFF.

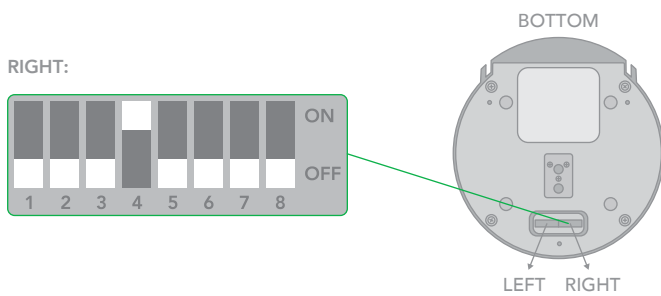

1. Bit 1~4: Video Resolution Setting. It is recommended to set this to the most frequently used resolution and thereafter use the BirdUI to make changes.

1	2	3	4	Video Resolution
OFF	OFF	OFF	OFF	1080i59.94
OFF	OFF	OFF	ON	<b>1080p29.97</b>
OFF	OFF	ON	OFF	720p59.94
OFF	OFF	ON	ON	1080p59.94
OFF	ON	OFF	OFF	Empty
OFF	ON	OFF	ON	1080i60
OFF	ON	ON	OFF	1080p30
OFF	ON	ON	ON	1080p60
ON	OFF	OFF	OFF	1080i50
ON	OFF	OFF	ON	1080p25
ON	OFF	ON	OFF	720p50
ON	OFF	ON	ON	1080p50
ON	ON	OFF	OFF	Empty
ON	ON	OFF	ON	Empty
ON	ON	ON	ON	720p60

2. Bit 5~6: Reserved

3. Bit 7~8: IR Remote Controller ID Setting

7	8	IR Remote Controller ID
OFF	OFF	1
ON	OFF	2
OFF	ON	3



## Using RS-232 (VISCA)

You can use the RS-232 port to connect to optional controllers, such as a joystick control keyboard, or control PC station, to operate the camera, perform pan, tilt and zoom operations and to use the Preset function using the control buttons.

An application software that supports this unit is needed if you use a PC station.

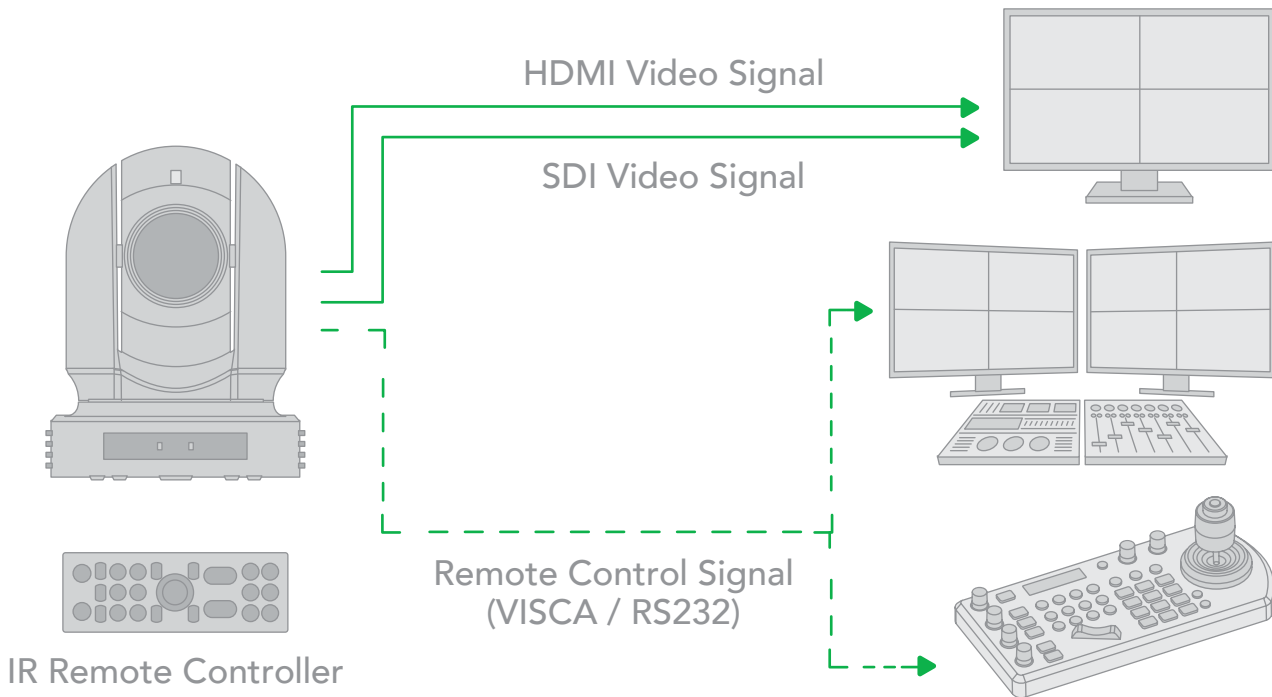

### RS232 Connection

1. On the base DIP switch:
  - Set for RS232 control.
  - Set the Baud Rate to the same setting as the keyboard you are using.
  - Set the specific address for the controlled camera.
2. If you want to have the camera address to be automatically assigned by VISCA controller, set the camera DIP switch address to 0.
3. Reboot the camera by turning it Off and On after the DIP switch has been set up correctly.
4. Use the included RJ45 to RS232 (VISCA) cable. The controller must be VISCA compatible.





5. You can use CAT5/6 cable (T-568B standard pinout) to make an RS232 connection by following the pin definition below:

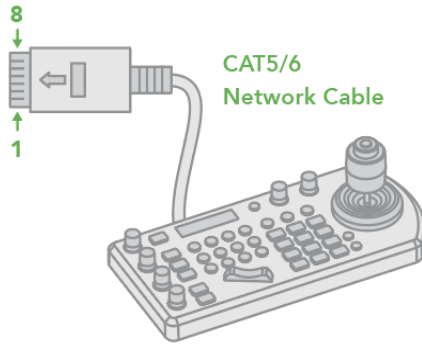

- |               |                      |
|---------------|----------------------|
| 1. ---        | (Orange/White)       |
| 2. ---        | (Orange)             |
| <b>3. GND</b> | <b>(Green/White)</b> |
| 4. ---        | (Blue)               |
| 5. ---        | (Blue/White)         |
| 6. ---        | (Green)              |
| 7. <b>TX</b>  | <b>(Brown/White)</b> |
| 8. <b>RX</b>  | <b>(Brown)</b>       |



## Using RS422(VISCA) / RS485 (PELCO P/D)

You can use the RS422/485 port connect to optional controllers, such as joystick control keyboard, control PC station, to operate the camera.

To perform pan/tilt and zoom operations using the joystick of the control keyboard, and to perform the Preset operation using the control buttons.

An application software that supports this unit is needed if you use PC station.

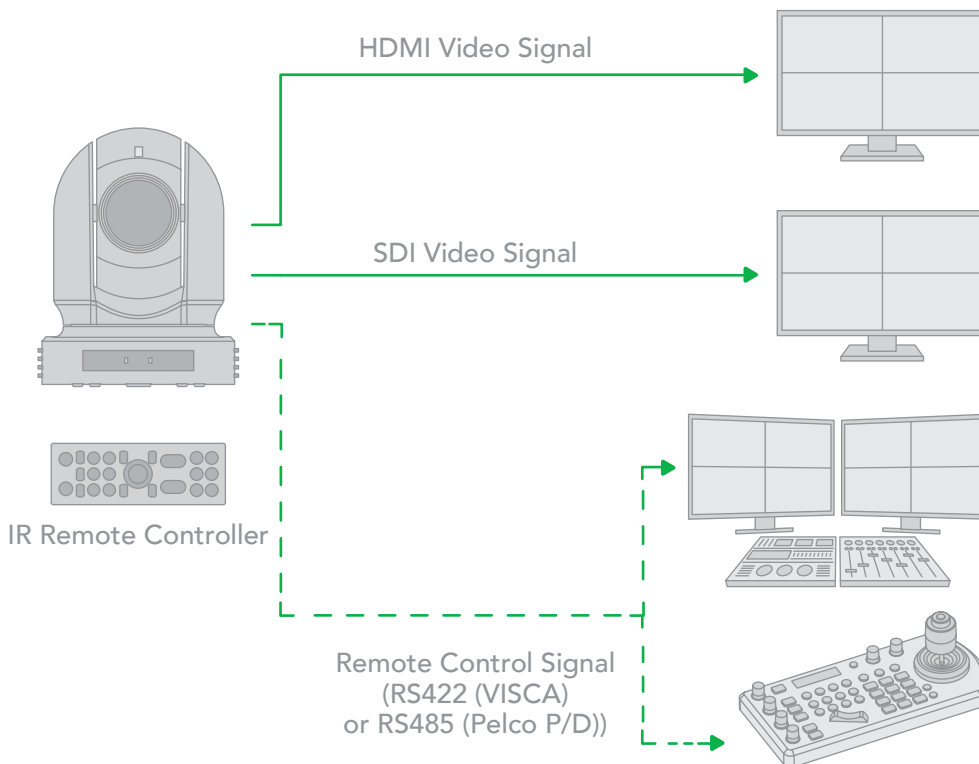

### RS422 (VISCA) connection

1. On the base DIP switch:
  - Set for RS422 control.
  - Set the Baud Rate on the DIP switch to the same Baud Rate as the keyboard you are using.
  - Set the specific address for the controlled camera.
2. If you want to have the camera address to be automatically assigned by VISCA controller, set the camera DIP switch address to 0.
3. Reboot the camera by turning it Off and On after the DIP switch has been set.
4. Use the included RJ45 to RS422 cable. The controller must be VISCA compatible.



- a. Use the included RJ45 to RS422 cable with a Phoenix connector adaptor to make an RS422 connection for your control device.

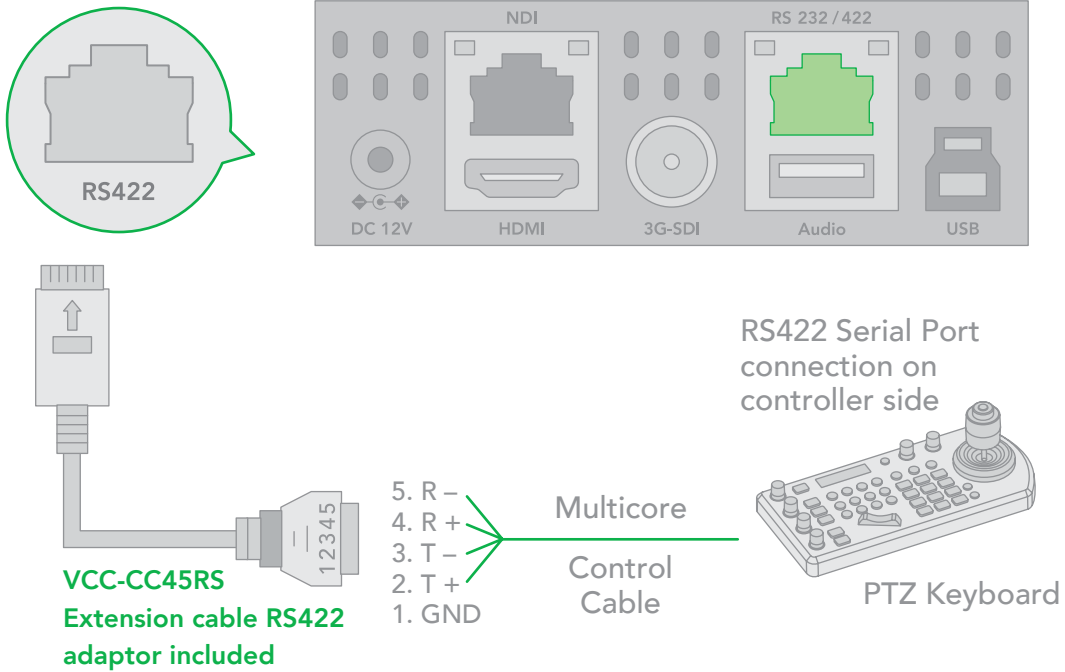

- b. You can use a CAT5/6 T-568B cable to make an RS422 direct connection between the camera and the controller by following the pin definition below.

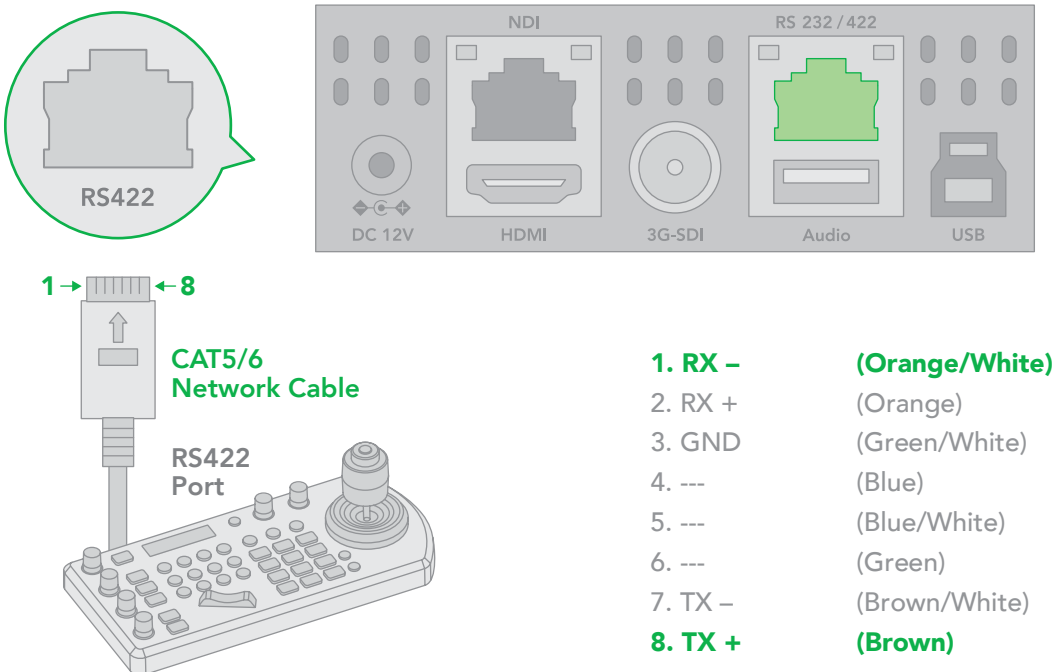



## PELCO P/D Keyboard RS485 Connection

**NOTE:** Use RS422 ports for RS485 connection. Only use TX+ and TX- for a RS485 connection.

1. On the base DIP switch:
    - Set the RS422 control method.
    - Set the the Baud Rate to the same setting as the keyboard you are using.
  2. Set the camera ID on the OSD menu by remote controller
  3. Reboot the camera by turning it Off and On after the DIP switch has been set up correctly.
  4. Use a PELCO P/D compatible keyboard.
  5. Use preset 95# on the keyboard to display/exit the camera OSD menu.
  6. Use the joystick and button "OPEN" or "CLOSE" to navigate OSD menu.
  7. To operate keyboard, please refer to the user manual of the keyboard you are using.
- a. Use the included RJ45 to RS422 cable with a Phoenix connector adaptor to make an RS485 connection for your control device.

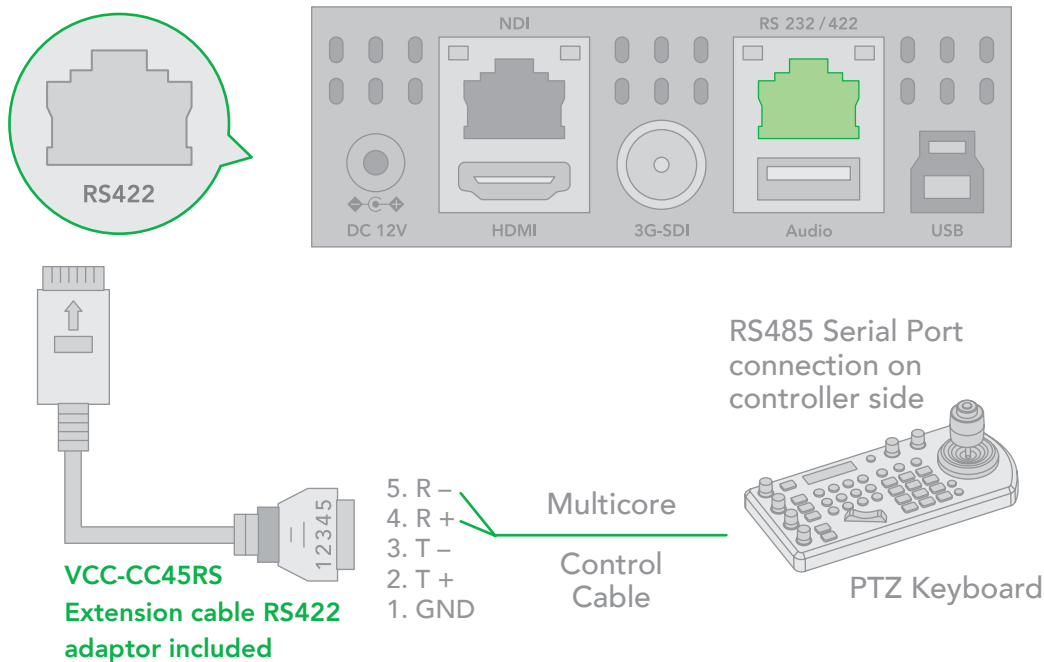



- b. Use a CAT5/6 T-568B cable direct connect between the camera and the controller to make an RS485 connection by following the pin definition below.

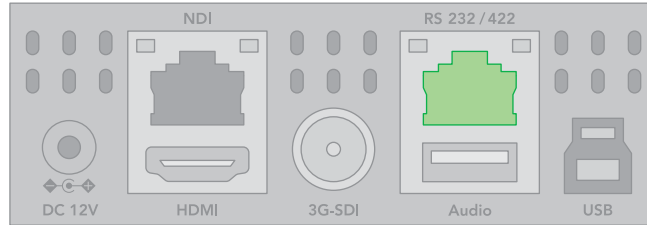
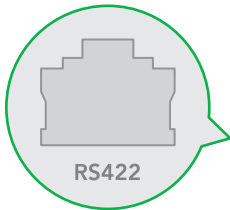

1 → ← 8

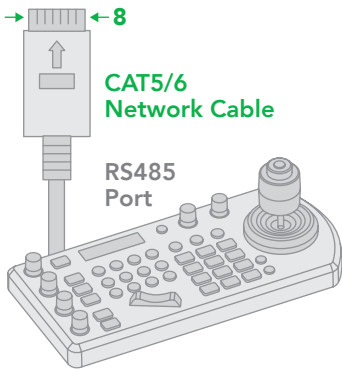

CAT5/6  
Network Cable

RS485  
Port

- |         |                |
|---------|----------------|
| 1. RX - | (Orange/White) |
| 2. RX + | (Orange)       |
| 3. GND  | (Green/White)  |
| 4. ---  | (Blue)         |
| 5. ---  | (Blue/White)   |
| 6. ---  | (Green)        |
| 7. TX - | (Brown/White)  |
| 8. TX + | (Brown)        |



## Camera Dimensions

Unit: mm

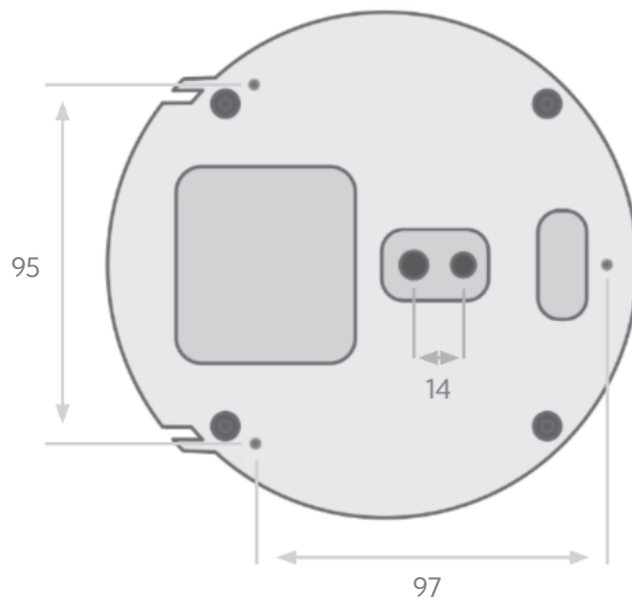
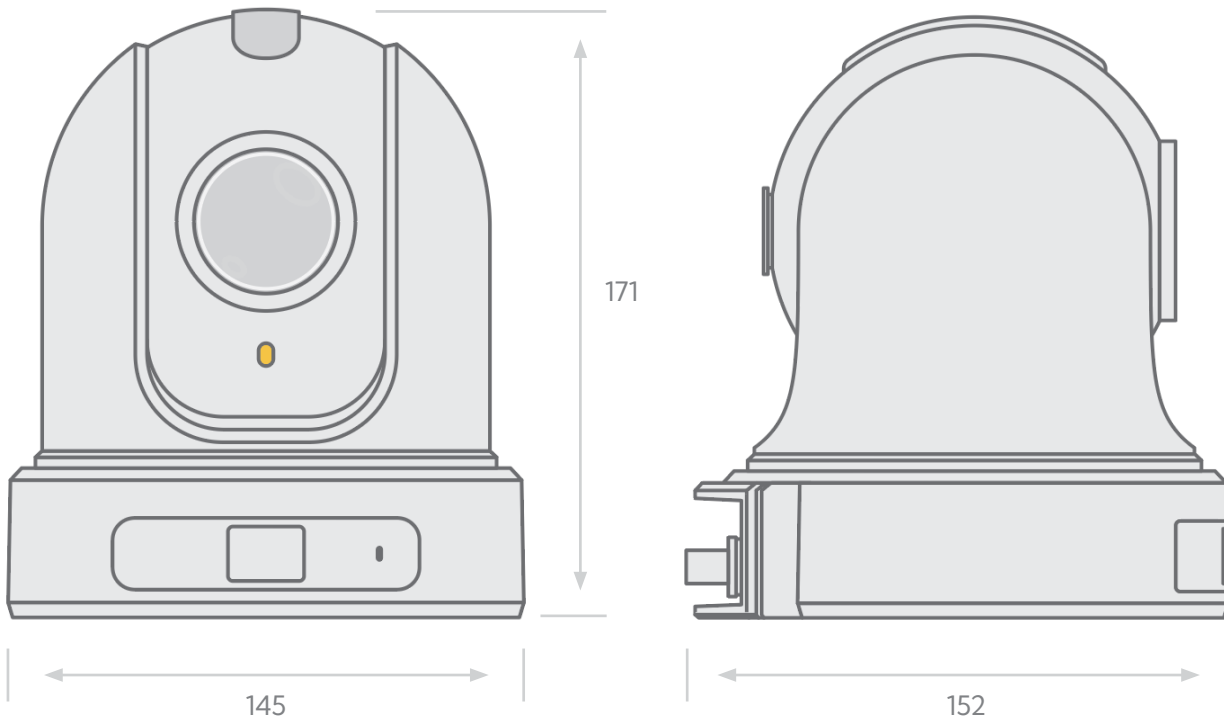



## Glossary

### Domain

A domain contains a group of computers that can be accessed and administered with a common set of rules. Domain can also refer to the IP address of a website on the Internet.

### DNS

DNS (Domain Name System) is a system used by the Internet and private networks to translate domain names into IP addresses.

### mDNS

mDNS (Multicast DNS) refers to the use of IP multicast with DNS to translate domain names into IP addresses and provide service discovery in a network that does not have access to a DNS server.

### Ethernet

Ethernet, standardized as IEEE 802.3, refers to a series of technologies used to connect computers and other devices to a LAN (Local Area Network) or wide area network (WAN).

### Firmware

Firmware is a class of software held in non-volatile memory that provides the low-level control for a device's hardware.

### Gigabit Ethernet (GigE)

An Ethernet capable of transmitting frames at a rate of a gigabit per second. A Gigabit capable Ethernet network is recommended for NDI® production workflows.

### IP

IP (Internet Protocol) is the communications protocol for the Internet, many wide area networks (WANs), and most local area networks (LANs) that defines the rules, formats, and address scheme for exchanging datagrams or packets between a source computer or device and a destination computer or device.

### LAN

LAN (Local Area Network) is a network that connects computers and devices in a room, building, or group of buildings. A system of LANs can also be connected to form a WAN (Wide Area Network).

### Mbps

Mbps (Megabits per second) is a unit of measurement for data transfer speed, with one megabit equal to one million bits. Network transmissions are commonly measured in Mbps.

### NDI®

NDI® (Network Device Interface) is a standard allowing for transmission of video using standard LAN networking. NDI® comes in two flavours, NDI® and NDI®|HX. NDI® is a variable bit rate, I-Frame codec that reaches rates of around 140Mbps at 1080p60 and is visually lossless. NDI®|HX is a compressed, long-GOP, H.264 variant that achieves rates around 12Mbps at 1080p60.

### PELCO

PELCO is a camera control protocol used with PTZ cameras. See also VISCA.

### PoE

Power over Ethernet

### Port

A port is a communications channel for data transmission to and from a computer on a network. Each port is identified by a 16-bit number between 0 and 65535, with each process, application, or service using a specific port (or multiple ports) for data transmission. Port can also refer to a hardware socket used to physically connect a device or device cable to your computer or network.



### **PTZ**

Pan, Tilt and Zoom.

### **RJ45**

A form of standard interface commonly used to connect computers onto Ethernet-based local area networks (LAN).

### **RS422, RS485, RS232**

Physical layer, serial communication protocols.

### **Subnet**

Subnet or subnetwork is a segmented piece of a larger network.

### **Tally**

A system that indicates the on-air status of video signals usually by the use of a red illuminated lamp.

### **TCP**

TCP (Transmission Control Protocol) is a network communications protocol.

### **UDP**

UDP (User Datagram Protocol) is an alternative protocol to TCP that is used when reliable delivery of data packets is not required.

### **VISCA**

VISCA is a camera control protocol used with PTZ cameras. See also PELCO.

### **WAN**

WAN (Wide Area Network) is a network that spans a relatively broad geographical area, such as a state, region, or nation.

### **White Balance**

White balance (WB) is the process of ensuring that white objects and by extension, all colour, in your video are rendered accurately. Without correct white balance, objects in your video display unrealistic color casts.





WELCOME TO THE FUTURE.

[birddog.tv](https://birddog.tv)  
hello@birddog.tv